

**N Concepta 25/30/40/50**

- patentovaný otočný / posuvný systém dveřního kování do pouzdra
- umožňuje zasunutí dveřního křídla do pouzdra
- kování je možné kombinovat se systémem Folding Concepta, pro skládací dveře do pouzdra
- univerzální levé / pravé řešení
- tlumené otevírání a zasunutí do pouzdra
- vhodné pro tloušťku dveří 19 až 50 mm



19 - 50 mm



zatížení  
25/30/40/50 kg

**Tipy na použití:**

- domácí kanceláře
- kuchyně
- funkční prostory v domě - prádelní skříně
- minimalistické byty



kód	výška dveří (mm)	hloubka korpusu (mm)	Concepta nosnost (kg)
<b>352466</b>	1250 – 1850	300 – 600	<b>25</b>
<b>352468</b>	1851 – 2300	300 – 900	<b>30</b>
<b>352479</b>	1851 – 2500	300 – 900	<b>40</b>
<b>352483</b>	2301 – 2850	300 – 900	<b>50</b>

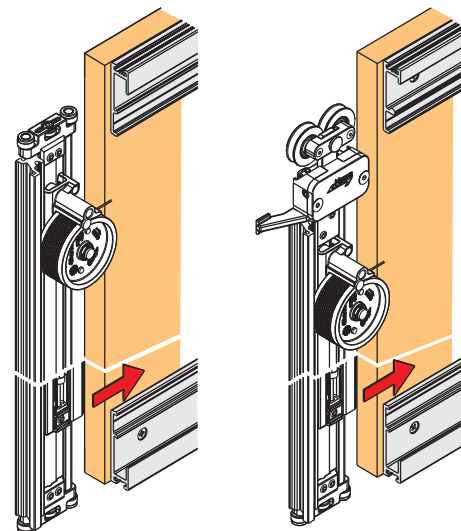
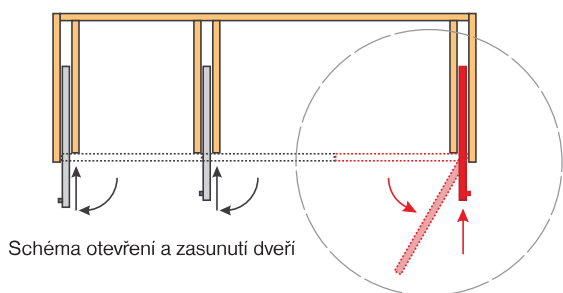

Kompletní návod přiložen u výrobku a ke stažení na portále.

Na [Hawa.com](http://Hawa.com) k dispozici dxf soubory, montážní videa a další pomůcky k usnadnění plánování a montáže.

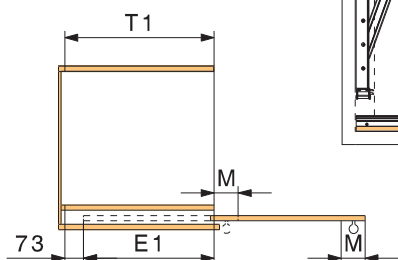
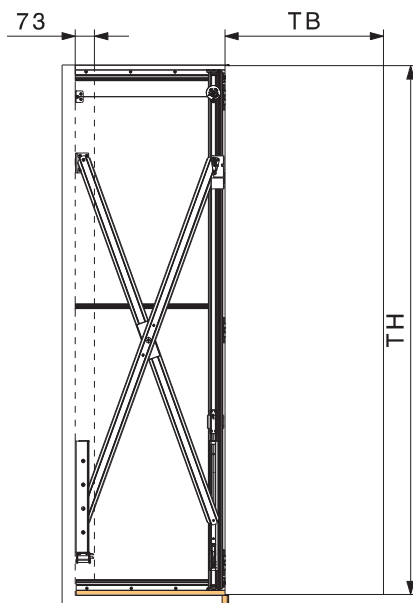

$$T1 = TB - M + 73 \text{ mm}$$

$$E1 = T1 - 73 \text{ mm}$$

kód	TB šířka dveří (mm)	TH výška dveří (mm)	E1 zasunutá část dveří (mm)
HAWA-Concepta 25	≤ 650	1250 – 1850	≤ 577
HAWA-Concepta 30	≤ 900	1851 – 2300	≤ 827
HAWA-Concepta 40	≤ 900	1851 – 2500	≤ 827
HAWA-Concepta 50	≤ 900	2301 – 2850	≤ 827

- TB - šířka dveří
- TH - výška dveří
- E1 - zasunutá část dveří
- T1 - celková hloubka
- M - přesah dveří

**!** u dveří širších 600 mm doporučujeme použít výtuhu, str. 5.96

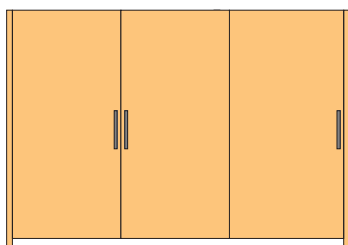
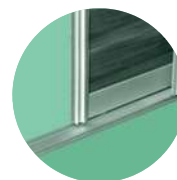

Montážní schéma pro naložené dveře s bočnicemi

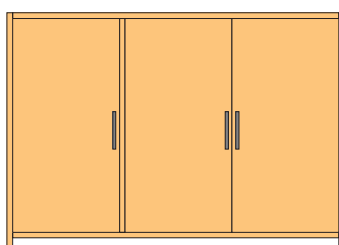

Montážní schéma pro vložené dveře

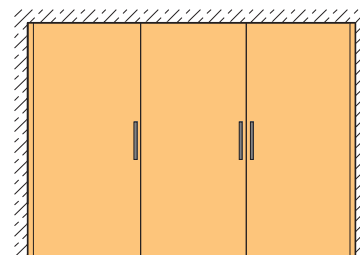

Montážní schéma pro dveře ve zdi

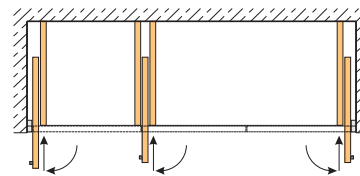
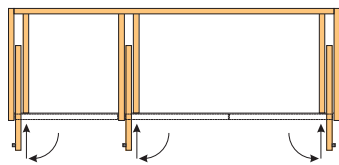
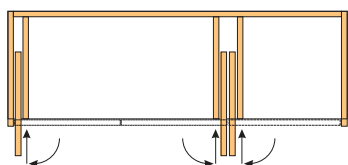

## Concepta 25/30/40/50

Tabulka rozměrů pro jednotlivé typy při dodržení maximální hmotnosti křídla

- podle rozměru a váhy křídel zvolte příslušný typ

výška (mm)	šířka (mm)												
	300	350	400	450	500	550	600	650	700	750	800	850	900
1250	25	25	25	25									
1300	25	25	25	25									
1350	25	25	25	25	25								
1400	25	25	25	25	25								
1450	25	25	25	25	25	25							
1500	25	25	25	25	25	25							
1550	25	25	25	25	25	25							
1600	25	25	25	25	25	25	25						
1650	25	25	25	25	25	25	25						
1700	25	25	25	25	25	25	25	25					
1750	25	25	25	25	25	25	25	25	25				
1800	25	25	25	25	25	25	25	25	25	25			
1850	25/30/40	25/30/40	25/30/40	25/30/40	25/30/40	25/30/40	25/30	25	25				
1900	30/40	30/40	30/40	30/40	30/40	30/40	30/40						
1950	30/40	30/40	30/40	30/40	30/40	30/40	30/40						
2000	30/40	30/40	30/40	30/40	30/40	30/40	30/40	30/40					
2050	30/40	30/40	30/40	30/40	30/40	30/40	30/40	30/40					
2100	30/40	30/40	30/40	30/40	30/40	30/40	30/40	30/40	30/40				
2150	30/40	30/40	30/40	30/40	30/40	30/40	30/40	30/40	30/40	30/40			
2200	30/40	30/40	30/40	30/40	30/40	30/40	30/40	30/40	30/40	30/40	30/40		
2250	30/40	30/40	30/40	30/40	30/40	30/40	30/40	30/40	30/40	30/40	30/40		
2300	30/40/50	30/40/50	30/40/50	30/40/50	30/40/50	30/40/50	30/40/50	30/40/50	30/40/50	30/40/50	30/40/50	50	
2350	40/50	40/50	40/50	40/50	40/50	40/50	40/50	40/50	40/50	40/50	40/50	40/50	50
2400	40/50	40/50	40/50	40/50	40/50	40/50	40/50	40/50	40/50	40/50	40/50	40/50	50
2450	40/50	40/50	40/50	40/50	40/50	40/50	40/50	40/50	40/50	40/50	40/50	40/50	50
2500	40/50	40/50	40/50	40/50	40/50	40/50	40/50	40/50	40/50	40/50	40/50	40/50	40/50
2550	50	50	50	50	50	50	50	50	50	50	50	50	50
2600	50	50	50	50	50	50	50	50	50	50	50	50	50
2650	50	50	50	50	50	50	50	50	50	50	50	50	50
2700	50	50	50	50	50	50	50	50	50	50	50	50	50
2750	50	50	50	50	50	50	50	50	50	50	50	50	50
2800	50	50	50	50	50	50	50	50	50	50	50	50	50
2850	50	50	50	50	50	50	50	50	50	50	50	50	50