

Evolution

PATENTED

With the **Evolution** system, **fixing and adjustment elements are positioned on the lateral side of the door**, allowing a very small gap between the track and the door, leaving the **maximum freedom to the creativity in the door design**.

Created to stand out from the concept of traditional bracket, **Evolution** is a **revolutionary sliding system** for wooden doors also suitable to our Universal frame. **Evolution** is available with the **new Fluid soft closing dampers**, in order to achieve an optimal braking motion and a noiseless sliding quality for doors of all sizes.

Maximum load capacity up to **120 kg**.

Con il sistema **Evolution**, gli **elementi di fissaggio e regolazione sono posizionati lateralmente alla porta**; si ottiene uno spazio molto ridotto tra binario e porta, lasciando la **massima libertà di design della porta**.

Creato per distinguersi dal tradizionale concetto di staffa, **Evolution** è un **rivoluzionario sistema scorrevole** per porte in legno, compatibile anche con il nostro telaio Universal.

Evolution è disponibile con i **nuovi ammortizzatori Fluid**, per una ottimale frenatura e silenziosità di scorrimento per porte di tutte le larghezze.

Kit con portata fino a **120 kg**.





PATENTED

The classic bracket has evolved, becoming invisible

In times of difficult economic recovery, we often think about optimizing new solutions that well match the concepts of **simplicity and cost effectiveness**. So it happens that from a simple concept something extraordinary arises. Something extremely original, capable of rewriting all the rules.

Terno Scorrevoli, increasingly engaged in the development of products that can be functional and aesthetically pleasant, has created **Evolution**, a sliding system for internal wooden, which stands out from classic bracket systems.

Compared to traditional door bracket systems, **Evolution revolutionizes the sliding unit concept in several ways.**

La staffa tradizionale si evolve e diventa invisibile

In tempi di difficile ripresa economica si pensa sempre ad ottimizzare nuove soluzioni che sposino bene i concetti di **semplicità ed economicità**. Capita poi che proprio da un concetto semplice nasca qualcosa di straordinario. Qualcosa di talmente innovativo da riscrivere tutte le regole.

Terno Scorrevoli, sempre più attenta allo sviluppo di prodotti che possano essere funzionali ed esteticamente poco invasivi, ha creato **Evolution**, un sistema scorrevole per porte in legno, nato per distinguersi dal concetto tradizionale di staffa.

Rispetto ai tradizionali sistemi per porte a staffa, **Evolution rivoluziona il concetto di scorrevole in molti modi.**



Fully concealed recessed fitting

One of the main features of this system is the lack of any visual impact. In fact, the system is designed to be completely concealed, including the option of a recessed ceiling rail.

A scomparsa totale

Una delle caratteristiche più importanti è proprio quella di essere un sistema in grado non avere alcun impatto visivo. Il sistema è infatti progettato per scomparire completamente offrendo anche la possibilità di realizzare un'installazione con binario incassato a soffitto.

Reduced upper/lower gap

Its peculiar structure allows the side positioning of the fastening and adjustment systems; in this way, there is only a 2 mm upper gap between the guide and the door and a 6 mm gap between the floor and the door.

Luce superiore ed inferiore ridotta

La sua particolare costruzione fa sì che, sia il sistema di fissaggio, sia il sistema di regolazione, siano posizionati lateralmente; in questo modo si ottiene una luce superiore fra binario e porta di soli 2 mm e una luce tra porta e pavimento di 6 mm.

Noiseless with anti-bounce system

The bracket includes an innovative anti-bounce system which, together with the air shock absorbers, allows a stable and soft stop of the door.

Silenzioso, con antisobbalzo

La staffa include un innovativo sistema antisobbalzo che, in combinazione con i fermi ammortizzati ad aria, rendono l'arresto della porta stabile e morbido.

Evolution is a truly special patented system: its features make it interesting in every sense. Anyone who is looking for an enhanced door sliding system, will be thrilled about this recessed sliding system.

Evolution è un sistema brevettato davvero speciale: le sue caratteristiche lo rendono interessante sotto ogni punto di vista. Chiunque sia alla ricerca del perfezionamento dello scorrevole per porta non potrà fare a meno di essere entusiasta di questo sistema scorrevole a scomparsa.

WITH
FLUID[®]
TECHNOLOGY



BALL BEARINGS / CUSCINETTI A SFERA



50 kg

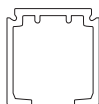

ART. 1280

8 00 0.01280

8 01 0.01280



80 kg

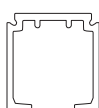

ART. 1280

8 00 0.01280

8 01 0.01280



120 kg

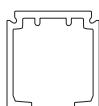

ART. 1280

8 00 0.01280

8 01 0.01280

Tracks / Binari

ALUMINUM FINISHES CODES / CODICI FINITURE ALLUMINIO



CODE / CODICE	FINISH COLOR / COLORE FINITURA				
8 00 0.0		00	G	Raw / Mill Finish / Neutro / Grezzo	STANDARD
8 01 0.0		01	A	Anodized Silver / Argento	
8 02 0.0		02	AS	Brushed Anodized Silver / Argento Spazzolato	
8 13 0.0		13	E3S	Brushed Anodized Dark Brown / E3 Spazzolato	SPECIAL
8 15 0.0		15	NS	Brushed Anodized Black / Nero Spazzolato	
8 17 0.0		17	NKS	Brushed Anodized Nickel / Nichel Spazzolato	

Evolution



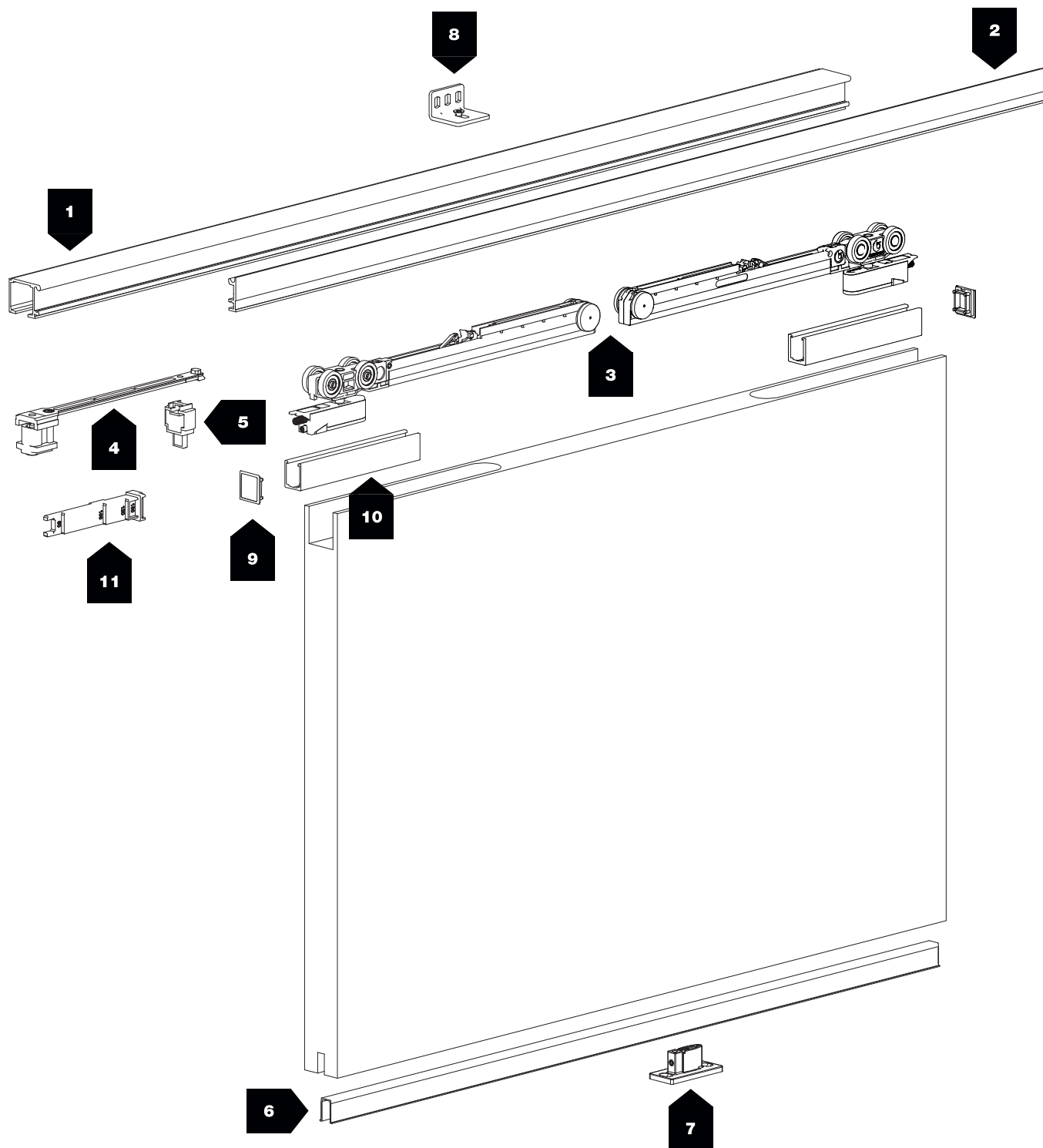





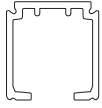

The invisible bracket sliding system
Sistema scorrevole con staffa invisibile

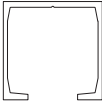

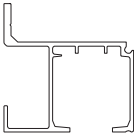
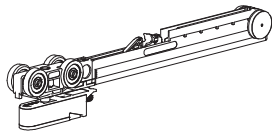

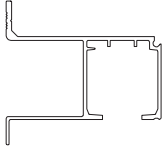
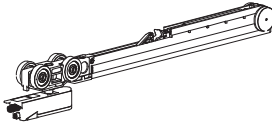

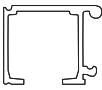
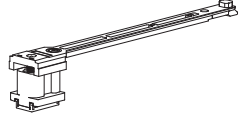
650 ÷ 1600 mm

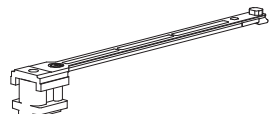

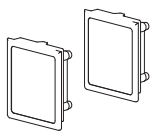
Min. 30 - Max 120 kg

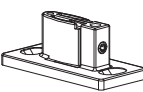
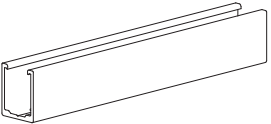
N°	Barcode		kg		N°	Barcode		kg		
1	1280 8 00 0.01280 8 01 0.01280		30÷120	STANDARD	2	1720 8 00 0.01720 8 01 0.01720		30÷120	OPTIONAL +	
	1080 8 00 0.01080 8 01 0.01080		30÷120	OPTIONAL +		1890 8 02 0.01890		-	OPTIONAL +	NEW
	1359 8 00 0.01359 8 01 0.01359		30÷120	OPTIONAL +		3390		30÷80	NEW  50 mm	
	1559 8 00 0.01559 8 01 0.01559		30÷120	OPTIONAL +		3362/080		50÷120	NEW  70 mm	
	1700 8 00 0.01700 8 01 0.01700		30÷120	OPTIONAL +		3387		30÷80	NEW	
2	1710 8 00 0.01710 8 01 0.01710		30÷120	OPTIONAL +	4	3354		50÷120		

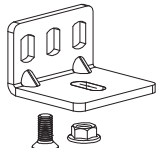
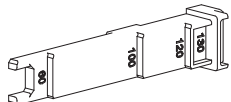
N°	Barcode		kg		N°	Barcode		kg	
5	3347		-		9	2354/A		-	
6	121 8 14 0.00121 8 23 0.00121		-	OPTIONAL +	9	2354/N		-	
7	333		30÷120		10	2351		50	
7	409		-		10	2356		80÷120	
8	127/D/V		30÷120		11	2364		-	

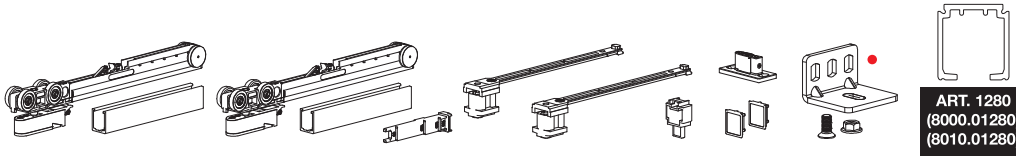







		OLD CODE	NEW CODE			
KIT	● N° 5	—	K.080.7.3.C	Min. 650 mm	—	4x
	—	—	K.080.7.3.S	Min. 650 mm	—	4x
BLISTER	● N° 4	—	B.080.7.3.C150	650 ÷ 850 mm	1500 mm	4x
	N° 5	—	B.080.7.3.C165	850 ÷ 950 mm	1650 mm	4x
	N° 5	—	B.080.7.3.C200	950 ÷ 1100 mm	2000 mm	4x
	N° 6	—	B.080.7.3.C250	1100 ÷ 1350 mm	2500 mm	4x
	N° 7	—	B.080.7.3.C300	1350 ÷ 1600 mm	3000 mm	4x
	—	—	B.080.7.3.S150	650 ÷ 850 mm	1500 mm	4x
	—	—	B.080.7.3.S165	850 ÷ 950 mm	1650 mm	4x
	—	—	B.080.7.3.S200	950 ÷ 1100 mm	2000 mm	4x
	—	—	B.080.7.3.S250	1100 ÷ 1350 mm	2500 mm	4x
	—	—	B.080.7.3.S300	1350 ÷ 1600 mm	3000 mm	4x

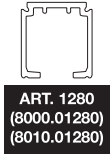
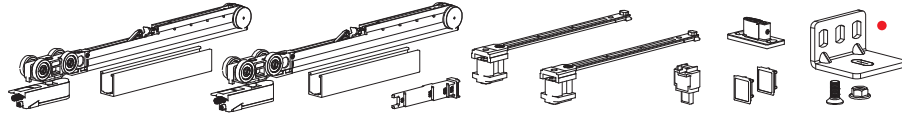



- 30 ÷ 80 kg**
- Min. 650 mm**
- 50 mm**
- N.2 Fluid dampers
N.2 Fermi ammortizzati
FLUID
- Ball bearings
Cuscinetti a sfera

Evolution





The invisible bracket sliding system
Sistema scorrevole con staffa invisibile



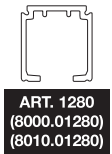
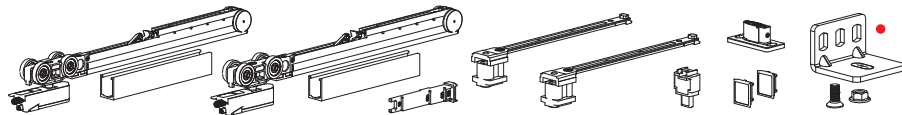



-  **50 kg**
-  **Min. 740 mm**
-  **70 mm**
-  N.2 Fluid dampers
N.2 Fermi ammortizzati Fluid
-  Ball bearings
Cuscinetti a sfera





		OLD CODE	NEW CODE		TRACK-BINARIO 		
KIT	•	N° 4	—	K.050.2.3.C	Min. 740 mm	—	4x
		—	—	K.050.2.3.S	Min. 740 mm	—	4x
BLISTER	•	N° 4	—	B.050.2.3.C150	740 ÷ 850 mm	1500 mm	4x
		N° 5	—	B.050.2.3.C165	850 ÷ 950 mm	1650 mm	4x
		N° 5	—	B.050.2.3.C200	950 ÷ 1100 mm	2000 mm	4x
		N° 6	—	B.050.2.3.C250	1100 ÷ 1350 mm	2500 mm	4x
		N° 7	—	B.050.2.3.C300	1350 ÷ 1600 mm	3000 mm	4x
		—	—	B.050.2.3.S150	740 ÷ 850 mm	1500 mm	4x
		—	—	B.050.2.3.S165	850 ÷ 950 mm	1650 mm	4x
		—	—	B.050.2.3.S200	950 ÷ 1100 mm	2000 mm	4x
		—	—	B.050.2.3.S250	1100 ÷ 1350 mm	2500 mm	4x
		—	—	B.050.2.3.S300	1350 ÷ 1600 mm	3000 mm	4x



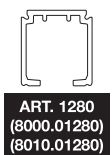
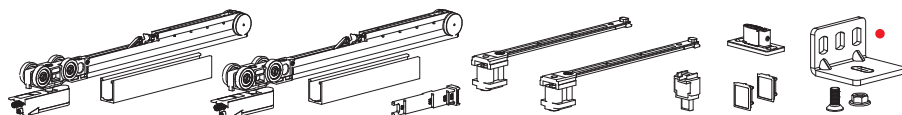



-  **80 kg**
-  **Min. 740 mm**
-  **70 mm**
-  N.2 Fluid dampers
N.2 Fermi ammortizzati Fluid
-  Ball bearings
Cuscinetti a sfera

		OLD CODE	NEW CODE		TRACK-BINARIO 		
KIT	•	N° 5	—	K.080.2.3.C	Min. 740 mm	—	4x
		—	—	K.080.2.3.S	Min. 740 mm	—	4x
BLISTER	•	N° 4	—	B.080.2.3.C150	740 ÷ 850 mm	1500 mm	4x
		N° 5	—	B.080.2.3.C165	850 ÷ 950 mm	1650 mm	4x
		N° 5	—	B.080.2.3.C200	950 ÷ 1100 mm	2000 mm	4x
		N° 6	—	B.080.2.3.C250	1100 ÷ 1350 mm	2500 mm	4x
		N° 7	—	B.080.2.3.C300	1350 ÷ 1600 mm	3000 mm	4x
		—	—	B.080.2.3.S150	740 ÷ 850 mm	1500 mm	4x
		—	—	B.080.2.3.S165	850 ÷ 950 mm	1650 mm	4x
		—	—	B.080.2.3.S200	950 ÷ 1100 mm	2000 mm	4x
		—	—	B.080.2.3.S250	1100 ÷ 1350 mm	2500 mm	4x
		—	—	B.080.2.3.S300	1350 ÷ 1600 mm	3000 mm	4x



-  **120 kg**
-  **Min. 740 mm**
-  **70 mm**
-  N.2 Fluid dampers
N.2 Fermi ammortizzati Fluid
-  Ball bearings
Cuscinetti a sfera

		OLD CODE	NEW CODE		TRACK-BINARIO 		
KIT	•	N° 6	—	K.120.2.3.C	Min. 740 mm	—	4x
		—	—	K.120.2.3.S	Min. 740 mm	—	4x
BLISTER	•	N° 4	—	B.120.2.3.C150	740 ÷ 850 mm	1500 mm	4x
		N° 5	—	B.120.2.3.C165	850 ÷ 950 mm	1650 mm	4x
		N° 5	—	B.120.2.3.C200	950 ÷ 1100 mm	2000 mm	4x
		N° 6	—	B.120.2.3.C250	1100 ÷ 1350 mm	2500 mm	4x
		N° 7	—	B.120.2.3.C300	1350 ÷ 1600 mm	3000 mm	4x
		—	—	B.120.2.3.S150	740 ÷ 850 mm	1500 mm	4x
		—	—	B.120.2.3.S165	850 ÷ 950 mm	1650 mm	4x
		—	—	B.120.2.3.S200	950 ÷ 1100 mm	2000 mm	4x
		—	—	B.120.2.3.S250	1100 ÷ 1350 mm	2500 mm	4x
		—	—	B.120.2.3.S300	1350 ÷ 1600 mm	3000 mm	4x

N.2 Fluid dampers - Min. 650 mm
N.2 Fermi ammortizzati Fluid - Min. 650 mm



30 kg
80 kg



50 mm

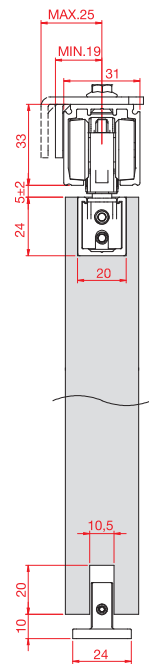
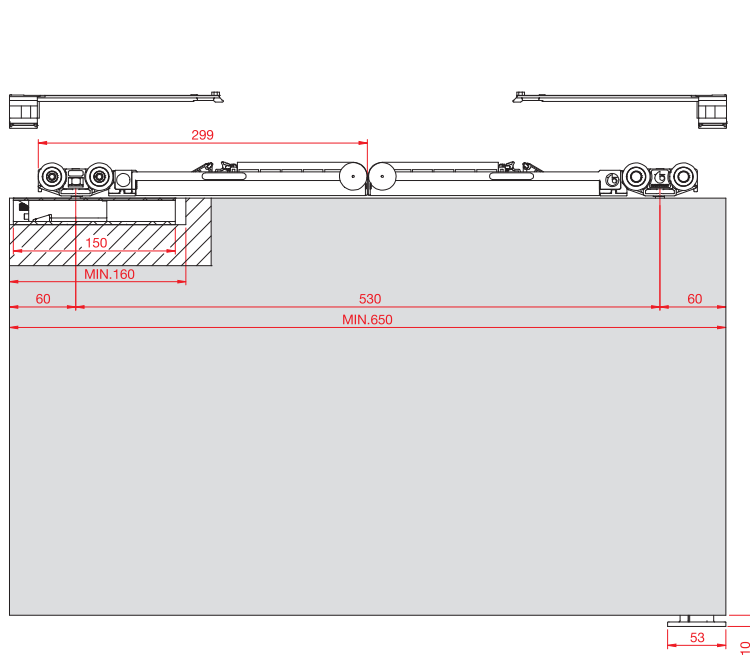

N.2 Fluid dampers - Min. 740 mm
N.2 Fermi ammortizzati Fluid - Min. 740 mm



50 kg
80 kg
120 kg



70 mm

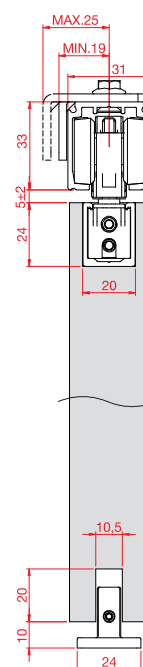
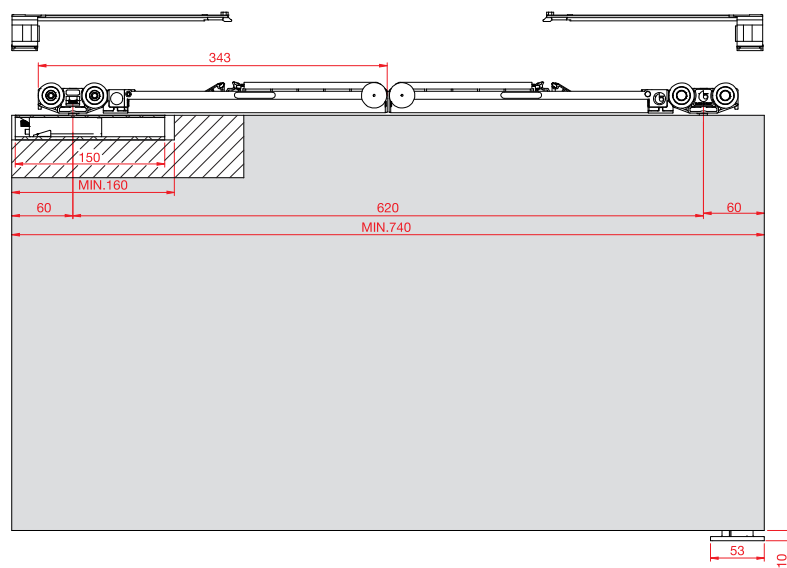

50 kg

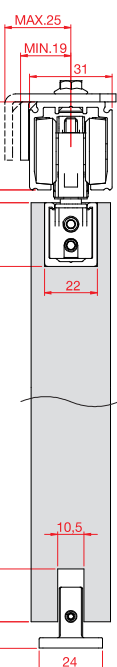

80-120 kg