

 **ITALIANA**[®]
ferramenta

Maori

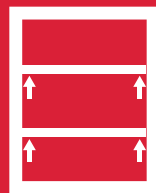

SHELF
SUPPORTS



SYMBOLS AND FINISHES LEGEND

SYMBOLS



= SHELF SAFELY LOCKED DURING TRANSPORTATION AND AT HOME.



= ANTI-TURNOVER LOCKING SYSTEM



= NORMS / PATENTS



= PHILLIPS / POZIDRIV



= WITH BUFFER



= PART NO.



= BLADE SLOT



= WITH MAGNET



= PCS. PER PACKAGE



= COMBI SLOT



= HEXAGONAL SOCKET



= NEWTON



= CAPACITY LOADING



= HEXALOBULAR SOCKET



= FRICTION



= WOOD / GLASS THICKNESS



= COUNTERSUNK HEAD



= AUTOMATIC



= HOLE DIAMETER



= PAN HEAD



= DROP DOWN



= DIAMETER



= FLANGE HEAD



= LENGTH



= FLAT HEAD



= STANDARD HINGE



= HEIGHT



= TRILOBULAR SCREW



= KIMANA HINGE



= RIGHT VERSION



= SELF-TAPPING SCREW



= FLAP HINGE



= LEFT VERSION



= EURO THREAD



= WITH SPRING



= SETTING CODE



= METRIC THREAD



= WITHOUT SPRING



= PCS. PER PAD



= PRE-INSERTED SCREW



= REVERSED SPRING



= CUT ON REQUEST



= PRE-INSERTED SCREW AND SPREADING BUSH



= SELF ADHESIVE



= WITH FLANGE

NOTE: Printing errors and omissions may exist despite our best efforts to ensure accuracy. We reserve the right to alter specifications without notice.

MATERIALS

ZA = Zinc Alloy

ST = Steel

HSS = High Speed Steel

BR = Brass

ABS = Acrylonitrile Butadiene Styrene

ZAnk = Nickel-plated Zinc Alloy

STzk = Zinc-plated Steel

AL = Aluminium

WD = Wood

EVA = Ethylene Vinyl Acetate

EP = **ENGINEERING PLASTIC**

+ **EP** = other engineering plastic available on request

SR = **SOFT RUBBER**

+ **SR** = other soft rubber available on request

EPn = Natural Engineering Plastic

EPc = Clear Engineering Plastic

SRn = Natural Soft Rubber

EPw = White Engineering Plastic

EPg = Grey Engineering Plastic

SRw = White Soft Rubber

EPwg = Water Green Engineering Plastic

SRb = Black Soft Rubber



FINISHES



= OTHER FINISHES AVAILABLE ON REQUEST

PART NO.	FINISHES	PART NO.	FINISHES	PART NO.	FINISHES
00	Insignificant finish	IF	Middle Grey	UT	T-Met 9007
AA	Natural	IJ	Light Grey	UZ	T-Met
AB	White	IL	Grey 20	WA	Bronzed
AE	White 9010	IN	Grey met. 26	WI	Burnished
EA	Black	JB	Bright Aluminium	XD	Satin-finished Steel
EC	Matt Black	JC	Aluminium - Chrome	YA	Nickel-plated
EE	Anthracite	JD	Matt Aluminium	YB	Bright Nickel-plated
EW	Grey 9007	JE	Satin-finished Aluminium	YC	Matt Nickel-plated
FU	Gunmetal	JF	Aluminium - Brass	YD	Satin-finished Nickel-plated
FV	Gunmetal V52	JG	Aluminium 5	YQ	Black Nickel
GR	Raw	JL	Aluminium PE 11	Z9	Black Zinc
HA	Brass-Plated	JM	Aluminium RAL 9006	ZA	Zinc alloy
HH	Tropicalized	KA	Chrome	ZN	Zinc-plated
HL	Raw Brass	KB	Bright Chrome	ZQ	Bright Gold
HX	Graphite	KC	Matt Chrome	ZY	Titanium
IA	Grey	NN	Metallic Beige	ZZ	Clear
IB	Metallic Grey	RO	Red		



MAORI

MAORI is a wood shelf support to be slotted into the panel by making face borings. It is ideal for modular cabinets, bookcases and modular furniture sporting a wide range of thicknesses. In fact MAORI can be used for shelves with minimum thickness of 12mm.

The small side bracket round ledge flushes with the lower side of the shelf making it aesthetically very elegant.

The panel has to be pushed downwards onto the side brackets, which can be screwed into any position required. The side bracket slots into the socket of the shelf supports and a click locks the panel in position.

On the shelves more than 12 mm thick, it is possible to fix the plastic support permanently using an additional Ø3mm screw.



12 mm min.

Certificates available on request.

INSTALLATION AND ASSEMBLING

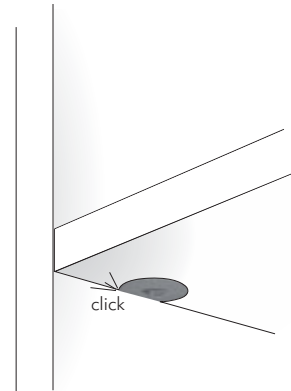
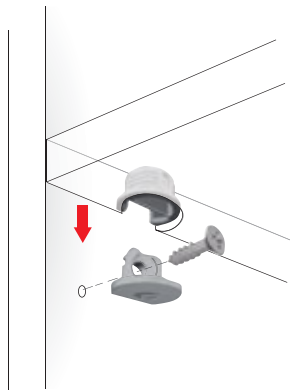
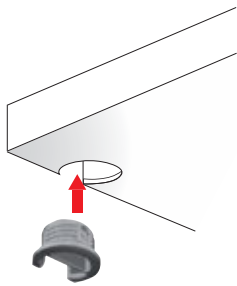

Assembling with alternative fixing options.

Assembling with pre-inserted spreading bush and screw to avoid hole damaging for shelf repositioning.

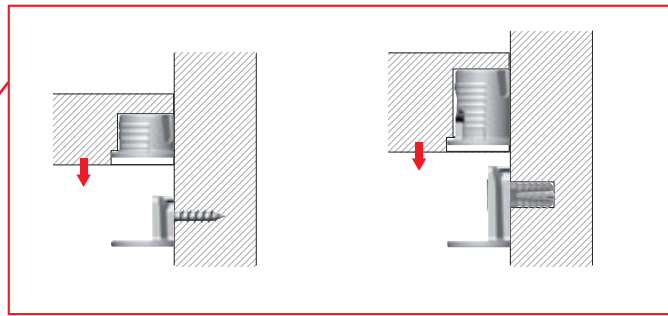
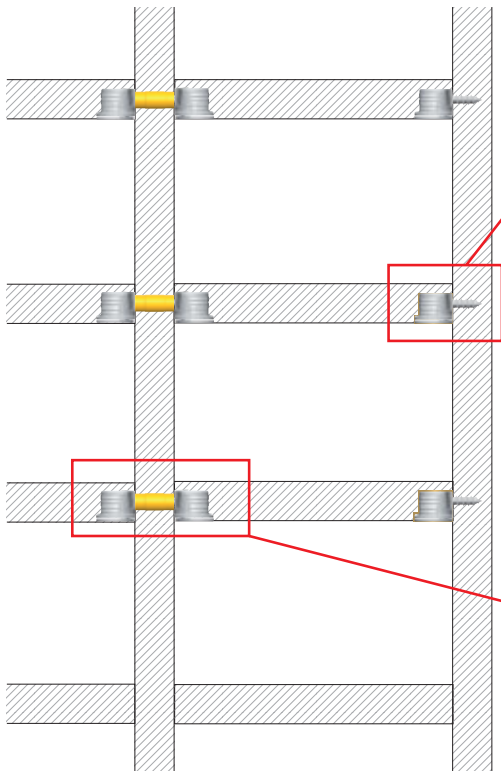

SPECIAL APPLICATION FOR SIDE PANEL 12 mm THICK:
Through hole fixing with metric sleeve.

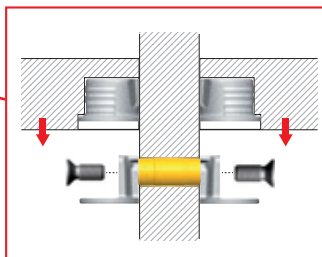

OPTIONAL FIXING (12mm thick version excluded):
To achieve much more horizontal connection.

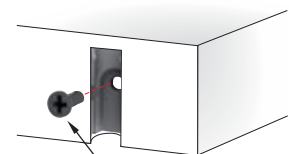

Optional fixing with pan head wood screw Ø 3 x 16 mm.

Also suitable for top and bottom panels when a back panel is used.



MAORI  12 mm

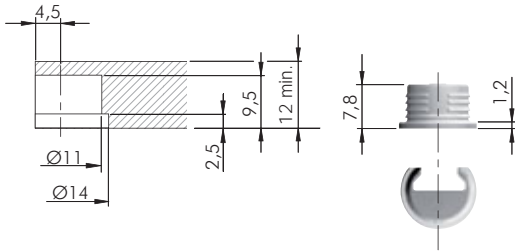





EP  = 30.000 pcs.

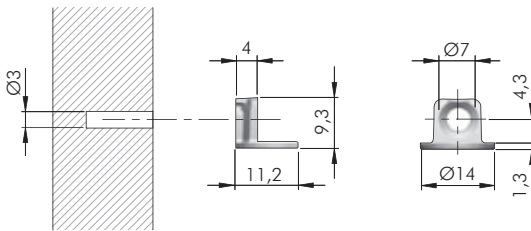

  |

11701010IL



 = Ø 3 mm  + 

ZA  = 5000 pcs.



  |

11702010YA

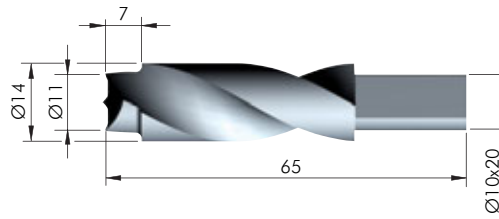
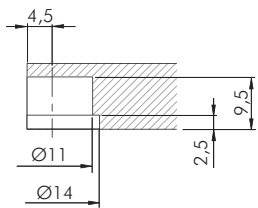
DRILL BIT FOR MAORI  12 mm



HSS  = on request

  |



1175201000 

1175205000 

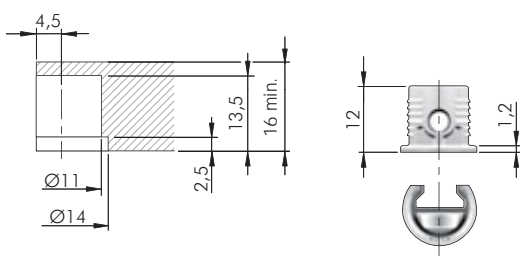
MAORI  16 mm



EP  = 20.000 pcs.

  |

11701040IL

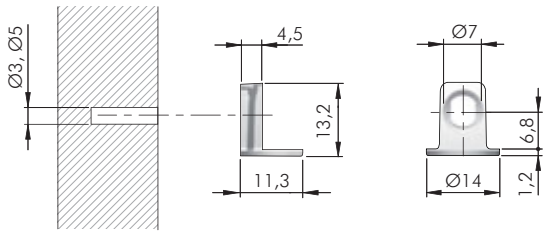

= Ø 3, Ø 5 mm +

= 5000 pcs.

11704010YA

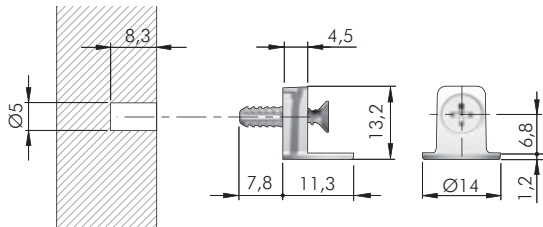

= Ø 5 mm +

= PZ2

= 2500 pcs.

11704030YA

DRILL BIT FOR MAORI 16 mm

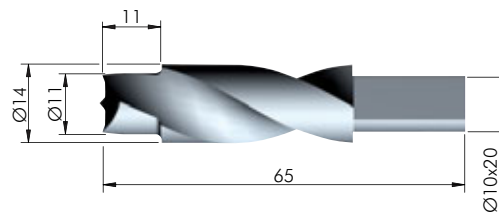
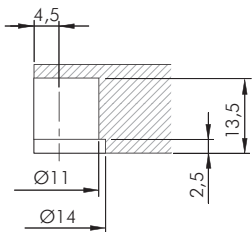

= on request

1175202000

1175206000

MAORI 18 - 19 mm

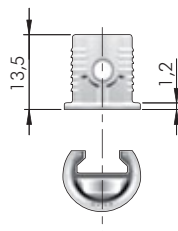
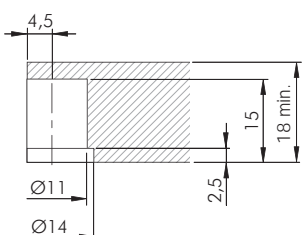

= 15.000 pcs.

11701070IL

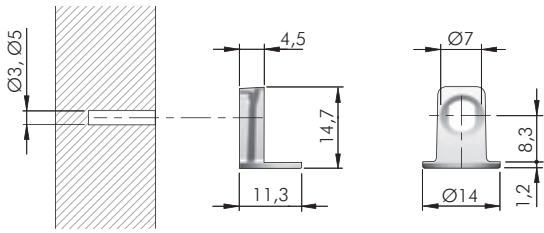

= Ø 3, Ø 5 mm +

= 5000 pcs.

11710010YA

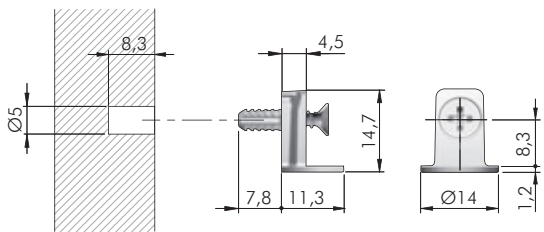

= Ø 5 mm +

= PZ2

= 2500 pcs.

11710030YA

DRILL BIT FOR MAORI 18 - 19 mm

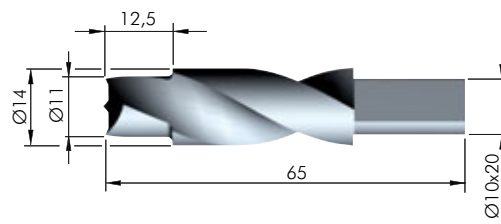
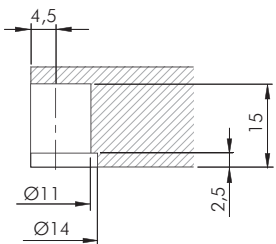

= on request

1175203000

1175207000

MAORI 25 mm

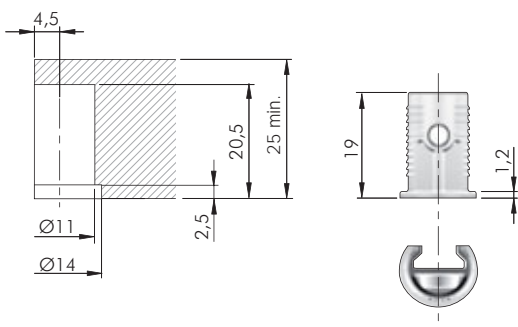

= 13.000 pcs.

11701100IL

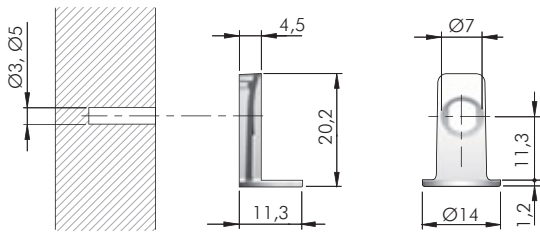

= Ø 3, Ø 5 mm +
 ZA = 2500 pcs.

11716010YA

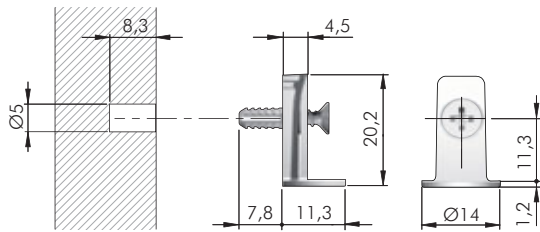

= Ø 5 mm +
 = PZ2
 ZA ST EP = 2500 pcs.

11716030YA

MAORI 29 mm

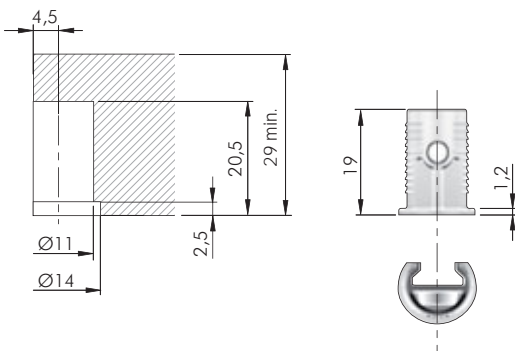

EP = 13.000 pcs.

11701100IL

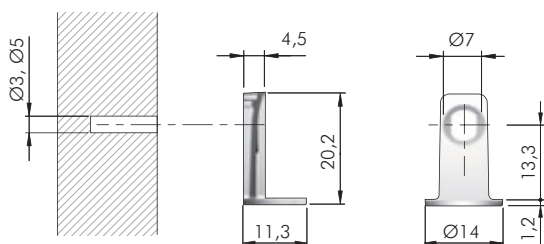

= Ø 3, Ø 5 mm +
 ZA = 5000 pcs.

11722010YA

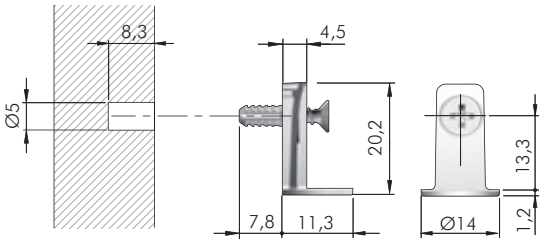

= Ø 5 mm +
 = PZ2
 = 2000 pcs.

11722030YA

DRILL BIT FOR MAORI 25, 29 mm

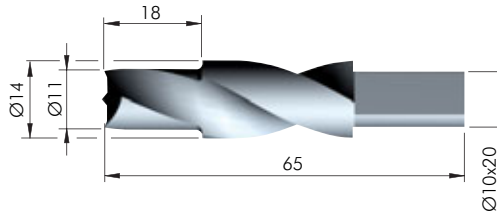
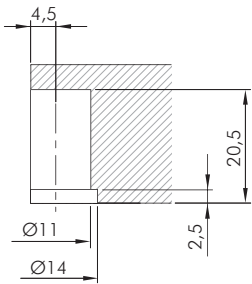

= on request

1175204000
1175208000

MAORI FIXING ACCESSORIES

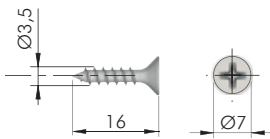

= Ø 3 mm +
 = PZ2
 = 10.000 pcs.

60101390ZN

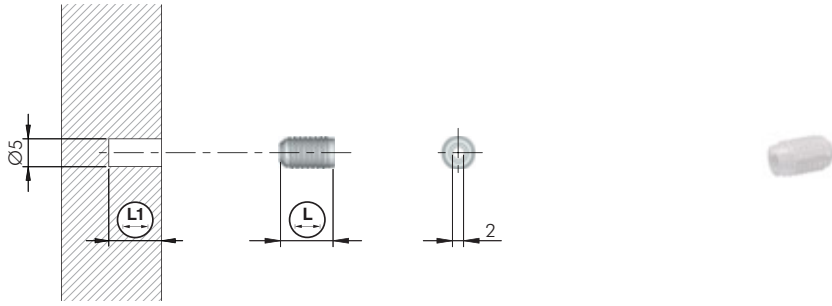

= Ø 5 mm

= 10.000 pcs.

20302020AA		9,5	11,5
20302030AA		13	15



= PZ2

= M4

= 10.000 pcs.

11750010ZN

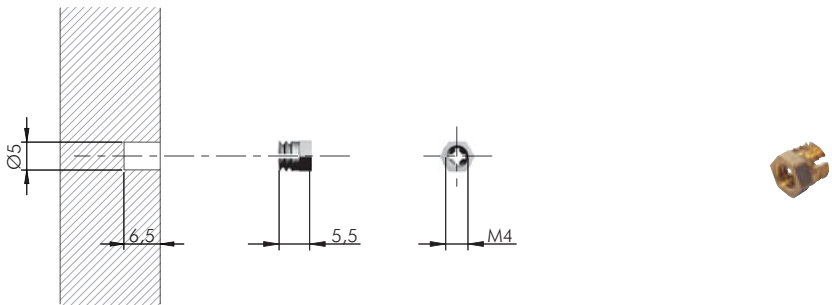

= Ø 5 mm

= M4

= 5000 pcs.

20502000HL

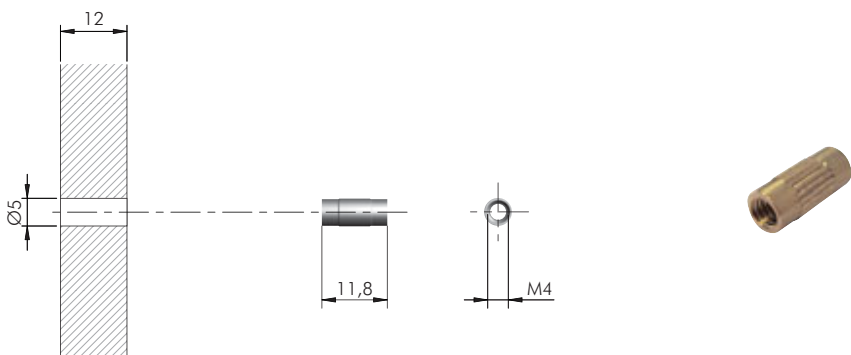

= Ø 5 mm

= 12 mm = M4

= 5000 pcs.

20801000HL

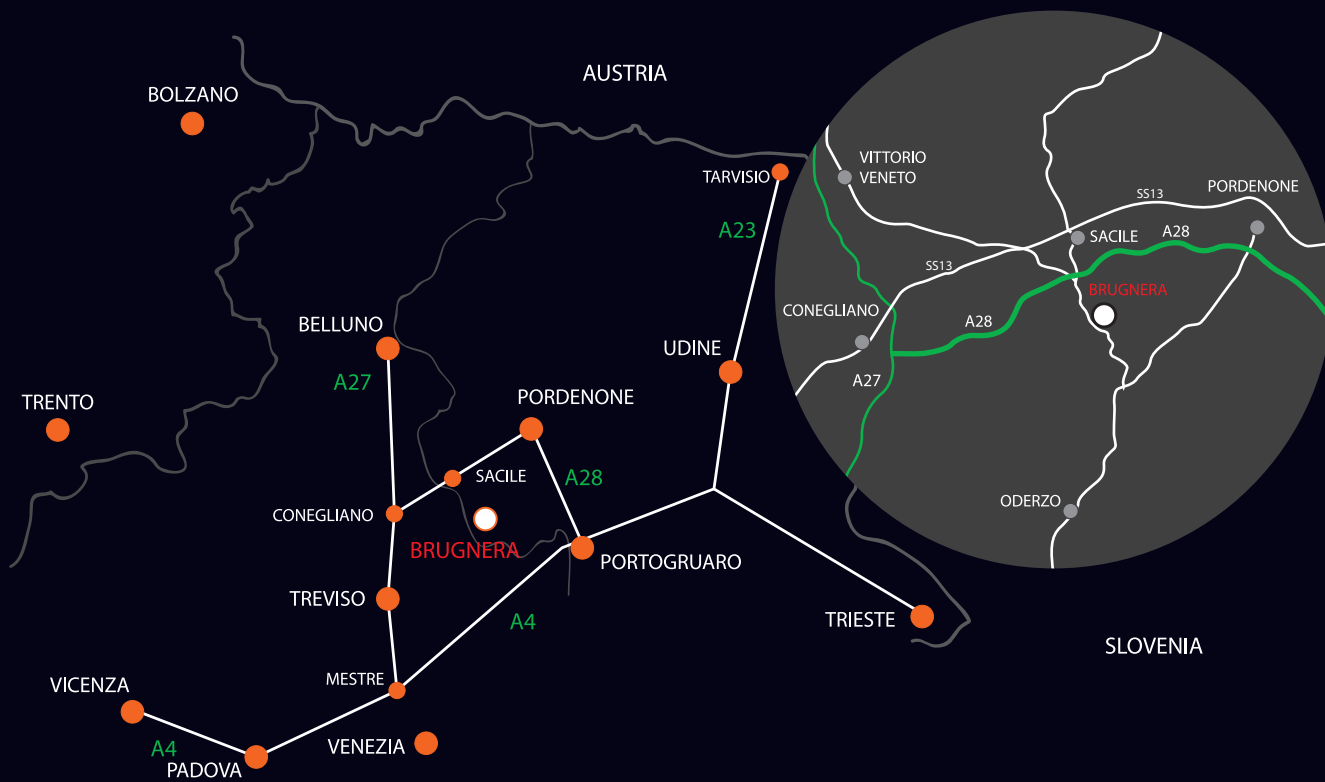

www.italianaferramenta.com