

A stelaż biurka regulowany x 2 szt | steel legs height adjustable x 2 pcs

A1

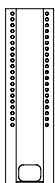

A2



A3

A4



B śruba x 8 szt | screw x 8 pcs



C klucz imbusowy x 1 szt | allen key x 1 pc



D zaślepka x 4 szt | end plug x 4 pcs



E regulator x 4 szt | adjustable feet x 4 pcs



F śruba x 8 szt | screw x 8 pcs



G klucz imbusowy x 1 szt | allen key x 1 pc



H wkręt x 8 szt | sharp screw x 8 pcs



potrzebne narzędzia | necessary tools



INSTRUKCJA MONTAŻU | ASSEMBLY INSTRUCTION

ST 221 R



2019.08

1

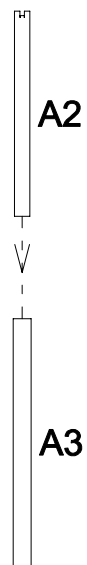

2

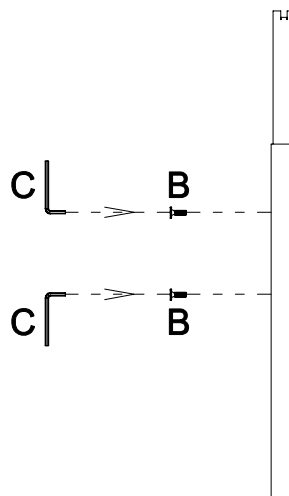

3

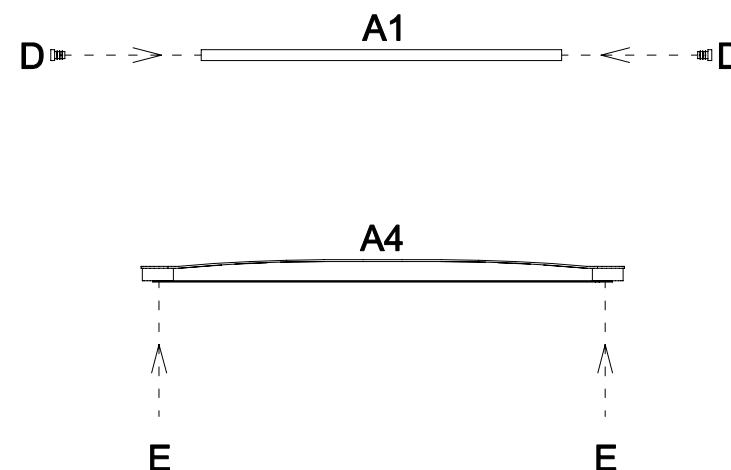

4

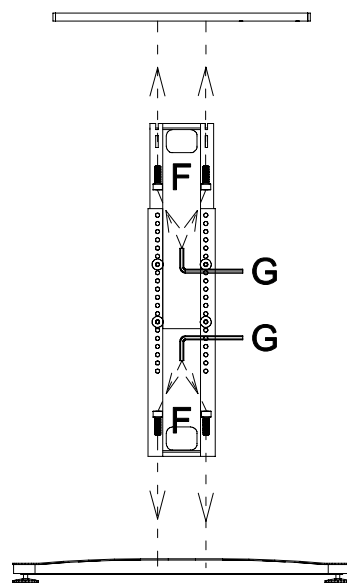

5

