

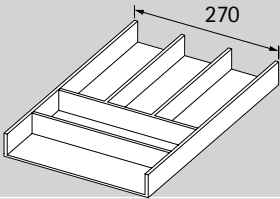

	AvanTech YOU / ArciTech		InnoTech / InnoTech Atira	AvanTech YOU / ArciTech / InnoTech / InnoTech Atira	
	NL 450	NL 500	NL 470		
A 	9 278 291	9 278 292	9 287 303		
B 	9 278 293	9 278 294	9 278 304		
C 	C1 L = 300 mm B = 105,5 mm 9 278 302	C2 L = 300 mm B = 118 mm 9 278 301	C3 L = 300 mm B = 115,5 mm 9 278 308	C4 L = 80 mm B = 135,5 mm 9 316 553	C5 L = 160 mm B = 135,5 mm 9 316 554
D 	9 283 424	9 283 413	9 308 346		
E 	9 283 425	9 283 414	9 308 348		
F 	9 283 423	9 283 426	9 308 347		
G 	L = 100 mm B = 600 mm: 9 278 313 B = 1200 mm: 9 279 203		L = 89 mm B = 600 mm: 9 278 314 B = 1200 mm: 9 279 204		
H 			9 278 309		
I 			9 278 310		
J 			9 278 312		

	AvanTech YOU / ArciTech		InnoTech / InnoTech Atira	AvanTech YOU / ArciTech / InnoTech / InnoTech Atira
	NL 450	NL 500	NL 470	
K 	K1 B = 93,5 mm 9 316 560 C1 : 9 278 302	K2 B = 106 mm 9 316 558 C2 : 9 278 301	K3 B = 103,5 mm 9 316 559 C3 : 9 278 308	K4 B = 123,5 mm 9 316 557 C4 : 9 316 553 C5 : 9 316 554
L 				9 316 555
M 				9 316 556

i

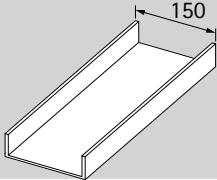
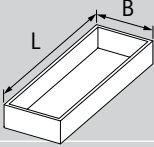
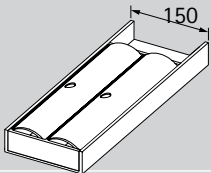
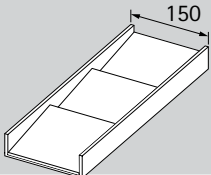
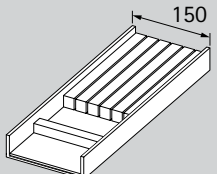
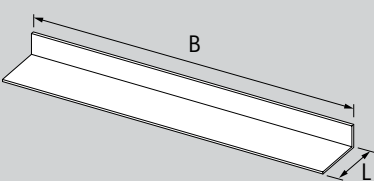
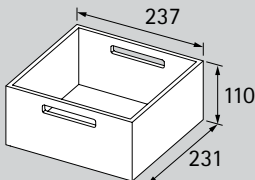
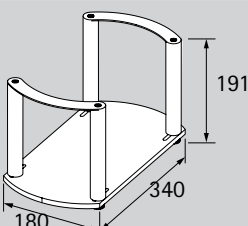

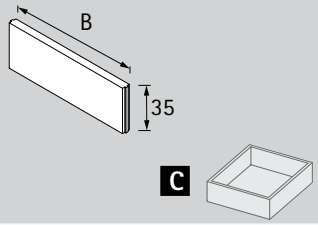
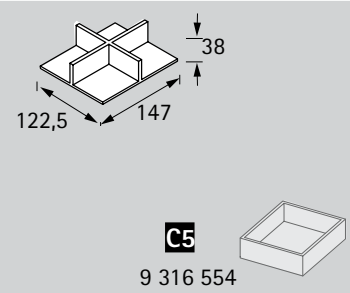
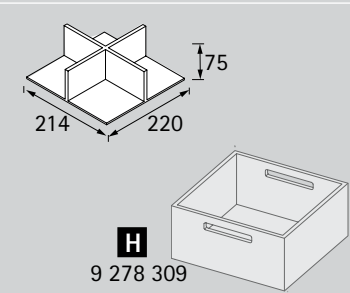
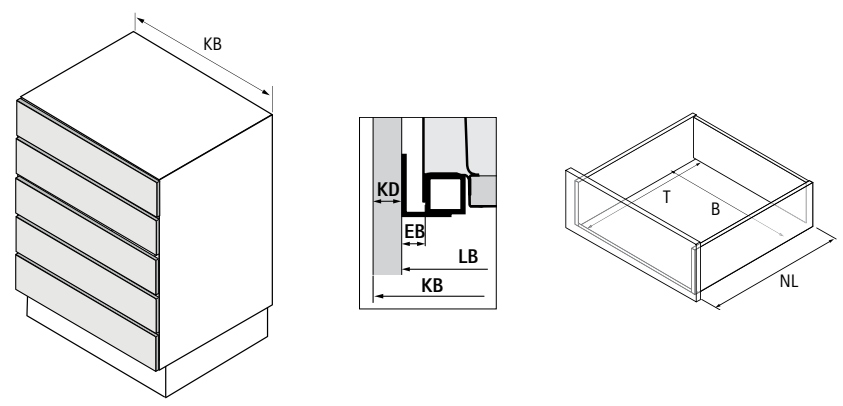
	B	T
AvanTech YOU	LB - 42	NL - 27
ArciTech	LB - 2 x EB - 62	NL - 27
InnoTech / InnoTech Atira	LB - 2 x EB - 59	NL - 8

NL ≥ 450 (470) mm

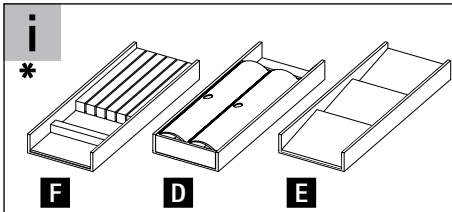
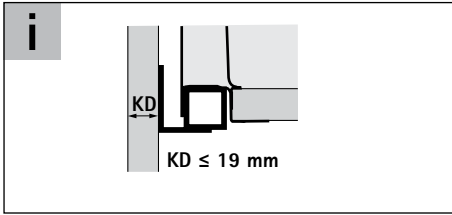

KB ≥ 350 AvanTech YOU
KB ≥ 400 ArciTech, InnoTech Atira

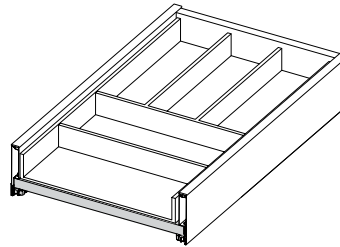

1 x **A**

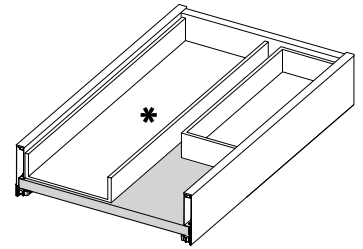

1 x **B** + 1 x **C1-3**

KB ≥ 400 AvanTech YOU
KB ≥ 450 ArciTech, InnoTech Atira

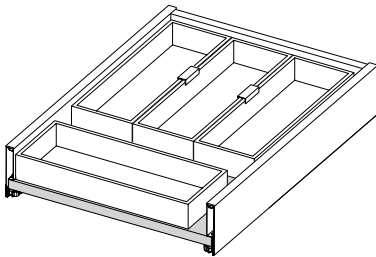

3 x **C1** + 1 x **C1-3** + 2 x **J**

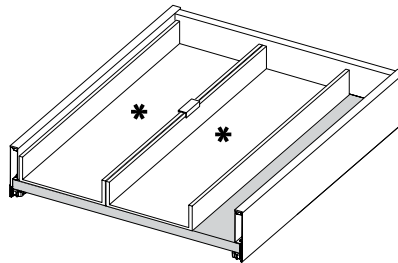

2 x **B** + 1 x **J**

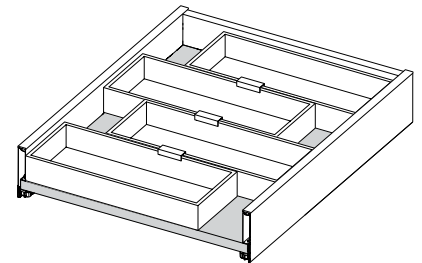

4 x **C1-3** + 3 x **J**

KB ≥ 450 AvanTech YOU
KB ≥ 500 ArciTech, InnoTech Atira

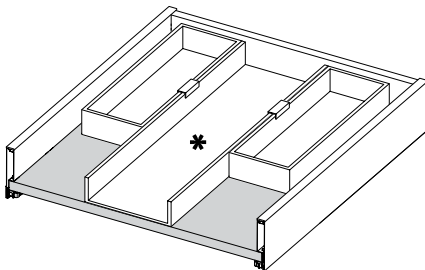

1 x **B** + 2 x **C1** + 2 x **J**

KB ≥ 500 AvanTech YOU
KB ≥ 550 ArciTech, InnoTech Atira

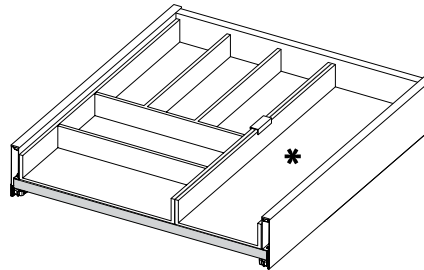

1 x **A** + 1 x **B** + 1 x **J**

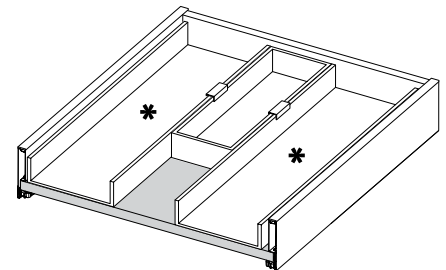

2 x **B** + 1 x **C1-3** + 2 x **J**

KB ≥ 550 AvanTech YOU
KB ≥ 600 ArciTech, InnoTech Atira

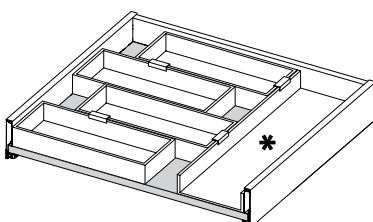

1 x **B** + 4 x **C1-3** + 2 x **J**

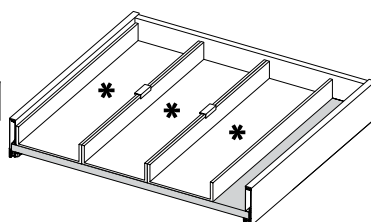

3 x **B** + 2 x **J**

KB ≥ 600 AvanTech YOU
KB ≥ 650 ArciTech, InnoTech Atira

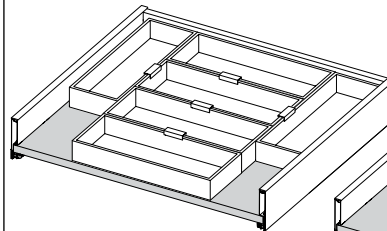

4 x **C** + 2 x **C1-3** + 5 x **J**

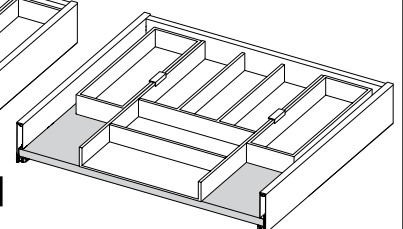

1 x **A** + 2 x **C1-3** + 2 x **J**

NL ≥ 450 (470) mm

KB ≥ 650 AvanTech YOU
KB ≥ 700 ArciTech, InnoTech Atira

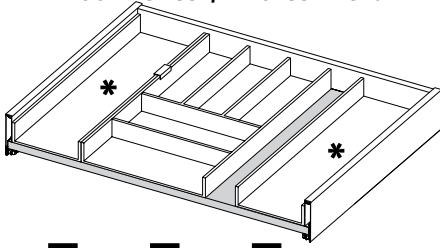

1 x **A** + 2 x **B** + 1 x **J**

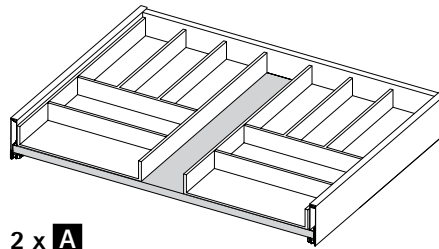

2 x **A**

KB ≥ 750 AvanTech YOU
KB ≥ 800 ArciTech, InnoTech Atira

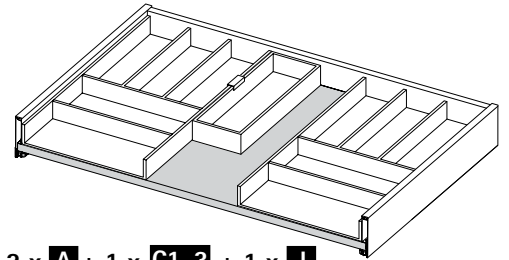

2 x **A** + 1 x **C1-3** + 1 x **J**

KB ≥ 800 AvanTech YOU
KB ≥ 850 ArciTech, InnoTech Atira

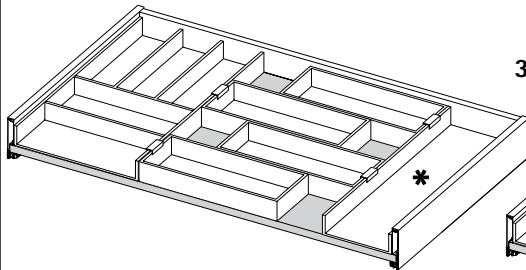

1 x **A** + 4 x **C1-3** + 1 x **B** + 4 x **J**

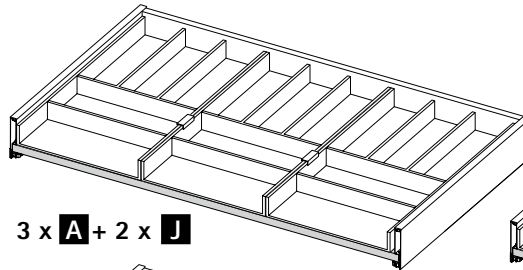

3 x **A** + 2 x **J**

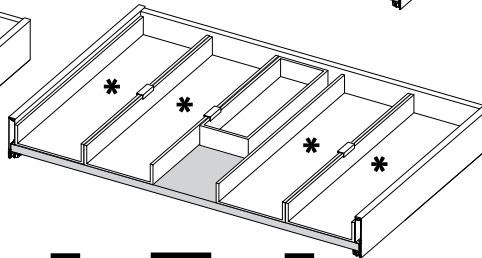

4 x **B** + 1 x **C1-3** + 3 x **J**

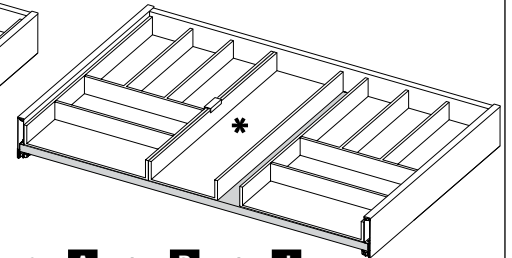

2 x **A** + 1 x **B** + 1 x **J**

KB ≥ 900 AvanTech YOU
KB ≥ 950 ArciTech, InnoTech Atira

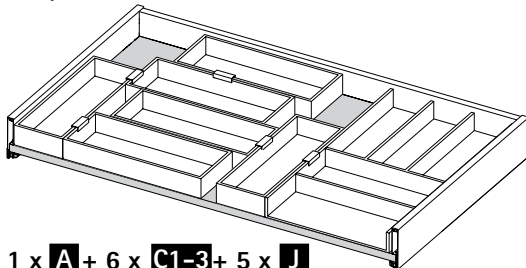

1 x **A** + 6 x **C1-3** + 5 x **J**

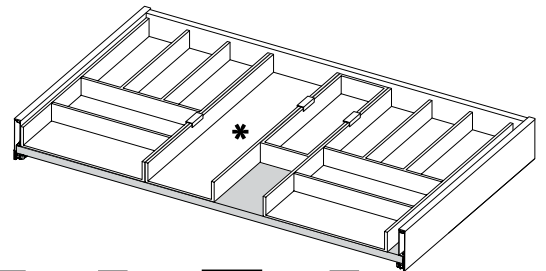

2 x **A** + 1 x **B** + 1 x **C1-3** + 3 x **J**

KB ≥ 950 AvanTech YOU
KB ≥ 1000 ArciTech, InnoTech Atira

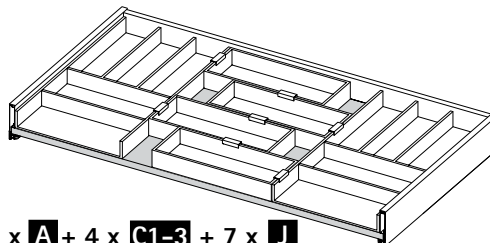

2 x **A** + 4 x **C1-3** + 7 x **J**

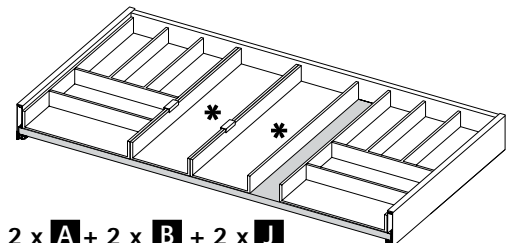

2 x **A** + 2 x **B** + 2 x **J**

KB ≥ 1000 AvanTech YOU
KB ≥ 1050 ArciTech, InnoTech Atira

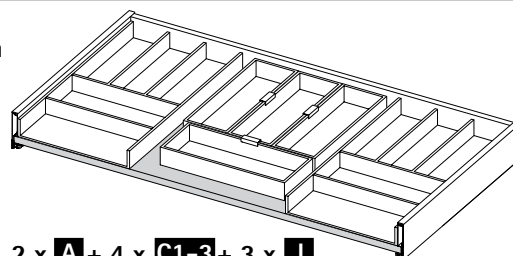

2 x **A** + 4 x **C1-3** + 3 x **J**

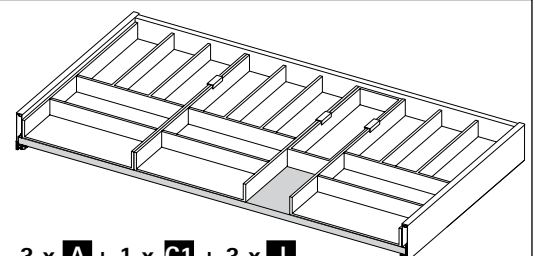

3 x **A** + 1 x **C1** + 3 x **J**

NL ≥ 450 (470) mm

KB ≥ 1150 AvanTech YOU
KB ≥ 1200 ArciTech, InnoTech Atira

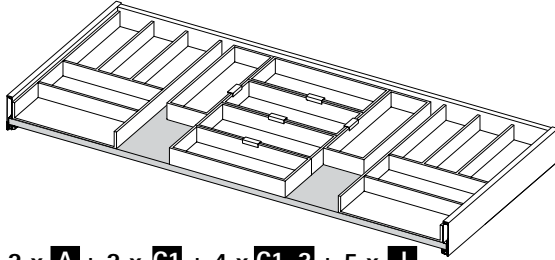

2 x **A** + 2 x **C1** + 4 x **C1-3** + 5 x **J**

KB ≥ 1200 AvanTech YOU

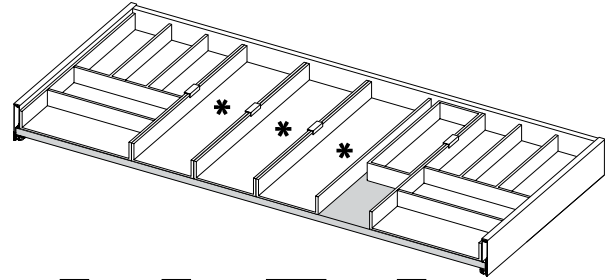

2 x **A** + 3 x **B** + 1 x **C1-3** + 4 x **J**

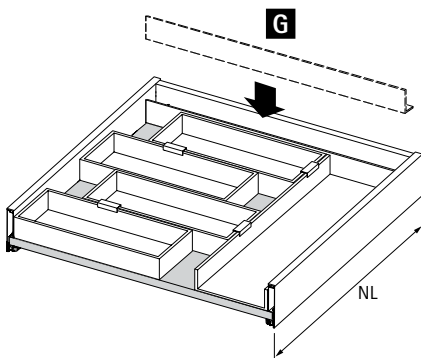

AvanTech YOU, ArciTech	NL			L = 100 mm B = 600 mm: 9 278 313 B = 1200 mm: 9 279 203
	450	A-F , NL 450		
500	A-F , NL 500			
550	A-F , NL 450		+ 1x G L = 100 mm	
600	A-F , NL 500		+ 1x G L = 100 mm	
650	A-F , NL 450		+ 2x G L = 100 mm	
InnoTech Atira	NL			L = 89 mm B = 600 mm: 9 278 314 B = 1200 mm: 9 279 204 L = 100 mm B = 600 mm: 9 278 313 B = 1200 mm: 9 279 203
	470	A-F , NL 470		
	520	A-F , NL 450		+ 1x G L = 89 mm
	620	A-F , NL 450		+ 1x G L = 89 mm + 1x G L = 100mm

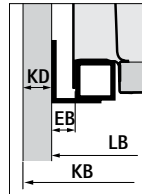
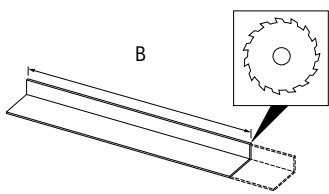

AvanTech YOU	B = LB - 42
ArciTech	B = LB - 2 x EB - 62
InnoTech Atira	B = LB - 2 x EB - 59

NL ≥ 270 (260) mm

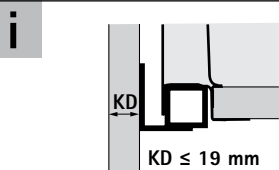

KB ≥ 250 AvanTech YOU
KB ≥ 300 ArciTech, InnoTech Atira

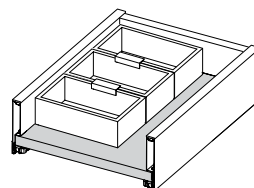

3 x **C4** + 2 x **J**

KB ≥ 300 AvanTech YOU
KB ≥ 350 ArciTech, InnoTech Atira

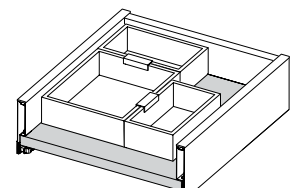

2 x **C4** + 1 x **C5** + 2 x **J**

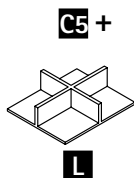
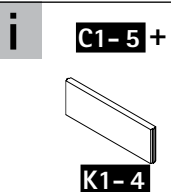

NL ≥ 270 (260) mm

KB ≥ 400 AvanTech YOU
KB ≥ 450 ArciTech, InnoTech Atira

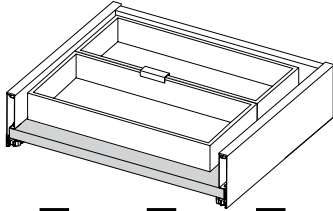

1 x **C2** + 1 x **C3** + 1 x **J**

KB ≥ 500 AvanTech YOU
KB ≥ 550 ArciTech, InnoTech Atira

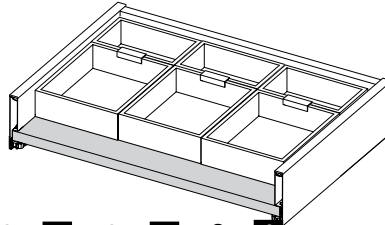

3 x **C4** + 3 x **C5** + 3 x **J**

KB ≥ 600 AvanTech YOU
KB ≥ 650 ArciTech, InnoTech Atira

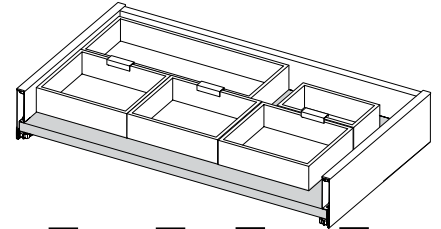

1 x **C1** + 1 x **C4** + 3 x **C5** + 3 x **J**

KB ≥ 700 AvanTech YOU
KB ≥ 750 ArciTech, InnoTech Atira

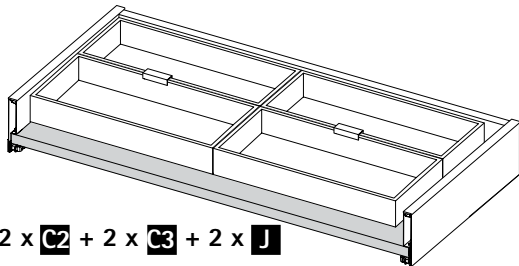

2 x **C2** + 2 x **C3** + 2 x **J**

KB ≥ 800 AvanTech YOU
KB ≥ 850 ArciTech, InnoTech Atira

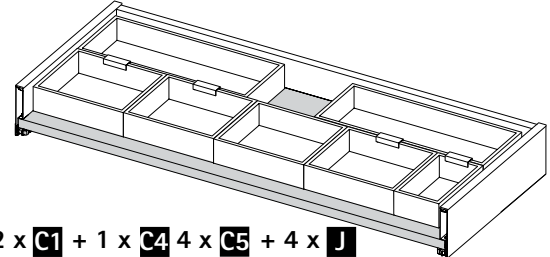

2 x **C1** + 1 x **C4** + 4 x **C5** + 4 x **J**

KB ≥ 900 AvanTech YOU
KB ≥ 950 ArciTech, InnoTech Atira

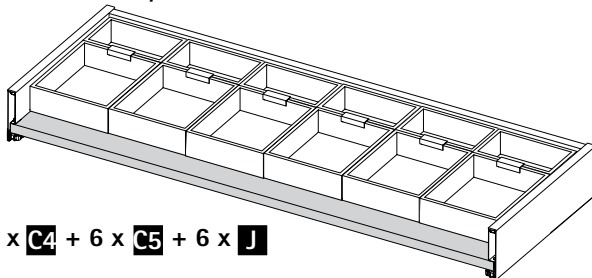

6 x **C4** + 6 x **C5** + 6 x **J**

KB ≥ 1000 AvanTech YOU
KB ≥ 1050 ArciTech, InnoTech Atira

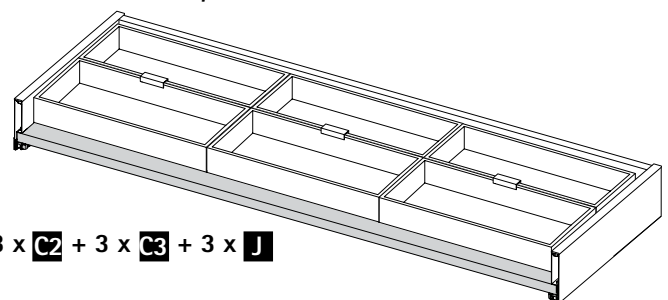

3 x **C2** + 3 x **C3** + 3 x **J**

NL ≥ 300 mm

i

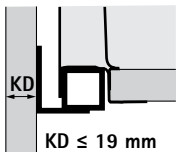

KB ≥ 250 AvanTech YOU
KB ≥ 300 ArciTech, InnoTech Atira

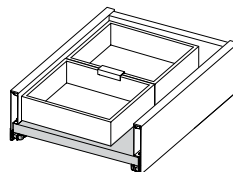

2 x **C5** + 1 x **J**

KB ≥ 300 AvanTech YOU
KB ≥ 350 ArciTech, InnoTech Atira

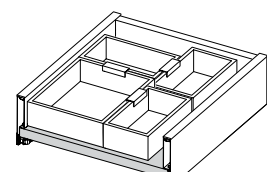

3 x **C4** + 1 x **C5** + 3 x **J**

i

C1-5 +



K1-4

C5 +

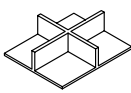

L

KB ≥ 400 AvanTech YOU
KB ≥ 450 ArciTech, InnoTech Atira

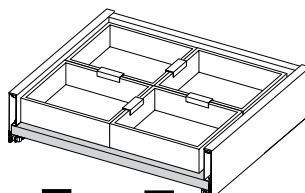

4 x **C5** + 4 x **J**

KB ≥ 500 AvanTech YOU
KB ≥ 550 ArciTech, InnoTech Atira

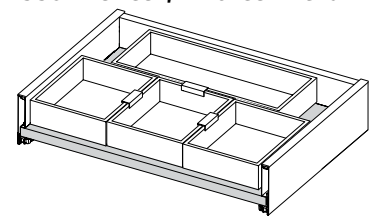

1 x **C1** + 3 x **C5** + 3 x **J**

NL ≥ 300 mm

KB ≥ 600 AvanTech YOU
KB ≥ 650 ArciTech, InnoTech Atira

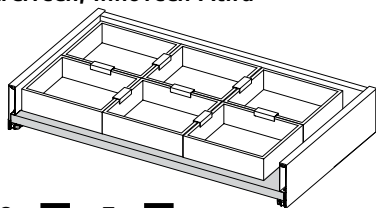

6 x **C5** + 7 x **J**

KB ≥ 800 AvanTech YOU
KB ≥ 850 ArciTech, InnoTech Atira

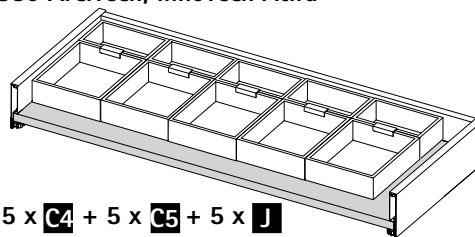

5 x **C4** + 5 x **C5** + 5 x **J**

KB ≥ 900 AvanTech YOU
KB ≥ 950 ArciTech, InnoTech Atira

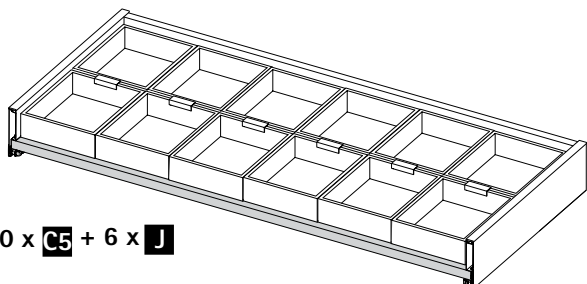

10 x **C5** + 6 x **J**

KB ≥ 1000 AvanTech YOU
KB ≥ 1050 ArciTech, InnoTech Atira

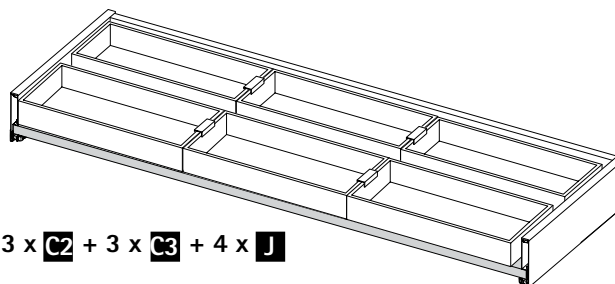

3 x **C2** + 3 x **C3** + 4 x **J**

NL ≥ 350 mm

i

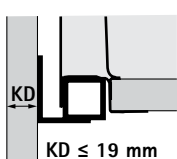

KB ≥ 250 AvanTech YOU
KB ≥ 300 ArciTech, InnoTech Atira

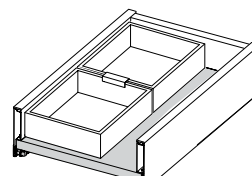

2 x **C5** + 1 x **J**

KB ≥ 300 AvanTech YOU
KB ≥ 350 ArciTech, InnoTech Atira

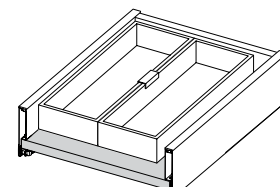

2 x **C1** + 1 x **J**

i

C1-5 +

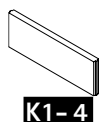

K1-4

C5 +

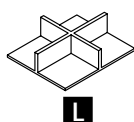

L

KB ≥ 400 AvanTech YOU
KB ≥ 450 ArciTech, InnoTech Atira

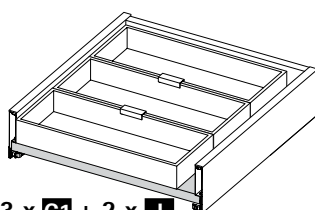

3 x **C1** + 2 x **J**

KB ≥ 500 AvanTech YOU
KB ≥ 550 ArciTech, InnoTech Atira

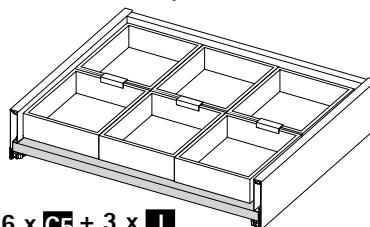

6 x **C5** + 3 x **J**

KB ≥ 600 AvanTech YOU
KB ≥ 650 ArciTech, InnoTech Atira

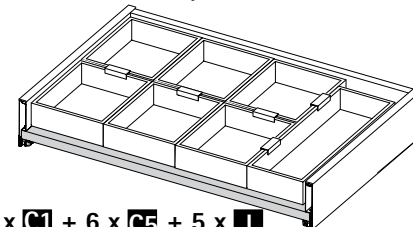

1 x **C1** + 6 x **C5** + 5 x **J**

KB ≥ 900 AvanTech YOU
KB ≥ 950 ArciTech, InnoTech Atira

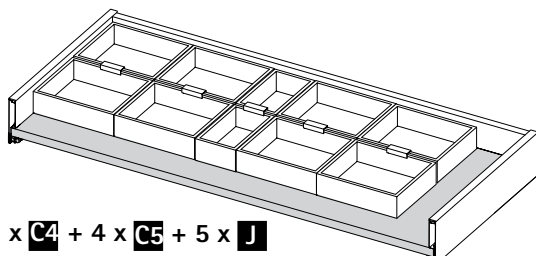

2 x **C4** + 4 x **C5** + 5 x **J**

KB ≥ 800 AvanTech YOU
KB ≥ 850 ArciTech, InnoTech Atira

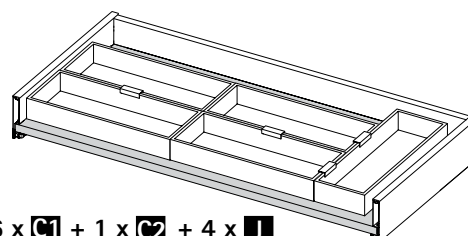

6 x **C1** + 1 x **C2** + 4 x **J**

NL ≥ 350 mm

KB ≥ 1000 AvanTech YOU
KB ≥ 1050 ArciTech, InnoTech Atira

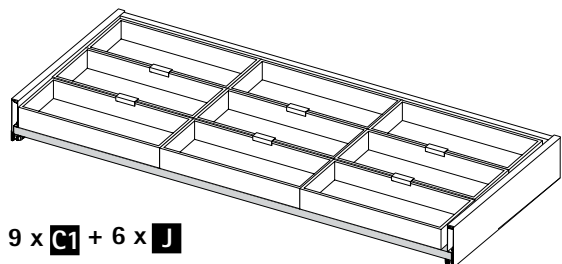

9 x **C1** + 6 x **J**

NL ≥ 400 mm

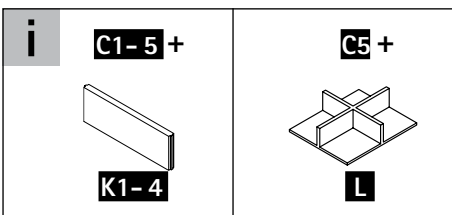
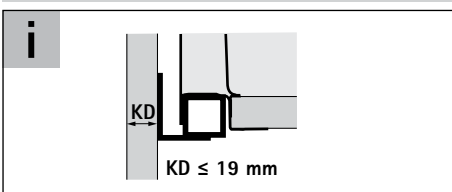

KB ≥ 250 AvanTech YOU
KB ≥ 300 ArciTech, InnoTech Atira

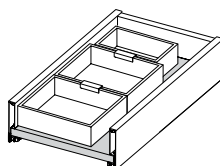

1 x **C1** + 2 x **C5** + 2 x **J**

KB ≥ 300 AvanTech YOU
KB ≥ 350 ArciTech, InnoTech Atira

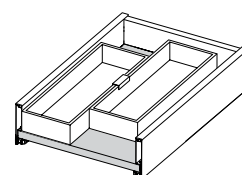

2 x **C1** + 1 x **J**

KB ≥ 400 AvanTech YOU
KB ≥ 450 ArciTech, InnoTech Atira

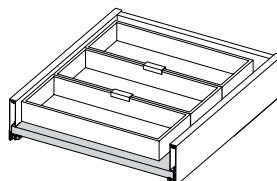

3 x **C2** + 2 x **J**

KB ≥ 500 AvanTech YOU
KB ≥ 550 ArciTech, InnoTech Atira

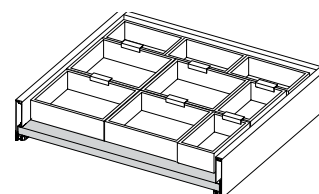

5 x **C4** + 4 x **C5** + 6 x **J**

KB ≥ 600 AvanTech YOU
KB ≥ 650 ArciTech, InnoTech Atira

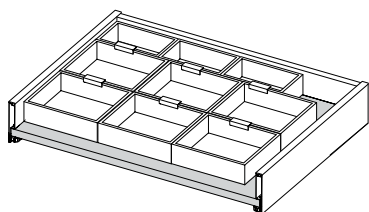

3 x **C4** + 6 x **C5** + 6 x **J**

KB ≥ 800 AvanTech YOU
KB ≥ 850 ArciTech, InnoTech Atira

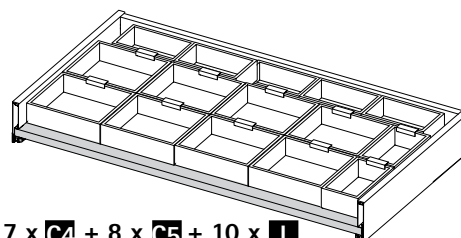

7 x **C4** + 8 x **C5** + 10 x **J**

KB ≥ 900 AvanTech YOU
KB ≥ 950 ArciTech, InnoTech Atira

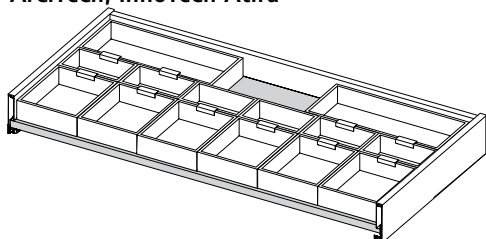

2 x **C2** + 6 x **C4** + 6 x **C5** + 10 x **J**

KB ≥ 1000 AvanTech YOU
KB ≥ 1050 ArciTech, InnoTech Atira

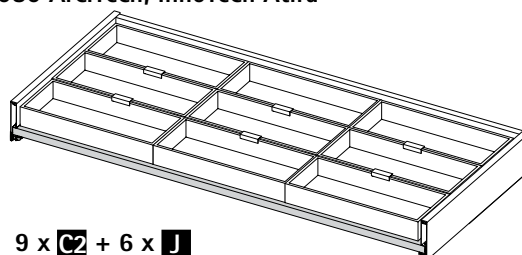

9 x **C2** + 6 x **J**