



Fine

The new aluminium frame for sliding doors
Il nuovo telaio in alluminio per ante scorrevoli



www.ternoscorrevoli.com/fine

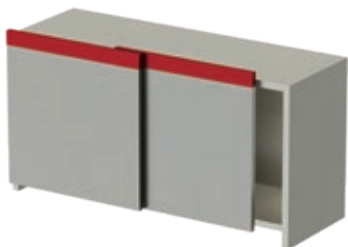

EXTERNAL OVERLAPPING DOORS
ANTE SOVRAPPOSTE ESTERNE

Fine

The aluminium frame for sliding doors - **elegant, functional and minimalist.**

Il telaio in alluminio per ante scorrevoli, **elegante, minimale e funzionale**



Design and Convenience

Not just beauty, but flexibility and sustainable costs as well.

Fine is the new aluminium frame for sliding doors, designed to meet the needs of a modern and sustainable market. The minimalist design can enhance the profile of wardrobes, making it possible to create modern solutions with a high aesthetic impact. Its technical and construction characteristics guarantee **reduced manufacturing and storage costs**. As the only work required is cutting the profiles at 90°, manufacturing costs and time can be optimised.

Following the construction standards we have provided, it will be possible to assemble the frame, doors, guides and sliding systems **with no extra cuts, holes or finishing work required**.

This ambivalent advantage translates into **great aesthetic value, very easy assembly and reduced manufacturing costs**.

Design e Praticità

Non solo bellezza, ma flessibilità e sostenibilità dei costi.

Fine è il nuovo telaio in alluminio, per ante scorrevoli, progettato per rispondere alle esigenze di un mercato moderno e sostenibile. Il design minimalista è in grado di esaltare le linee degli armadi, consentendo la realizzazione di soluzioni moderne e a forte impatto estetico.

Le sue caratteristiche tecniche e costruttive garantiscono una **riduzione dei costi di lavorazione e stoccaggio**. Grazie all'unica lavorazione necessaria: il taglio a 90° dei profili, è infatti possibile ottimizzare i tempi e i costi di lavorazione.

Seguendo gli standard costruttivi da noi forniti sarà possibile assemblare: telaio, ante, guide e sistemi scorrevoli **senza la necessità di ulteriori tagli, fori o lavorazioni aggiuntive**.

Un vantaggio ambivalente, che si traduce in: un **grande valore estetico**, un' **estrema praticità di montaggio** e una **riduzione dei costi** di lavorazione.

8 mm... Fine Thinner and more resistant than ever.

The new visible frame is **only 8 mm wide**. It is truly incredible if considering how resistant it is. Once assembled, **it guarantees fluid movement**, especially if combined with our **Star Fluid** sliding system.

8 mm... Fine Mai così sottile e resistente.

Il nuovo telaio a vista è **di soli 8 mm di larghezza**. Davvero incredibile, se si tiene conto della sua resistenza. Una volta assemblato, **garantisce** infatti una **scorrevolezza fluida** soprattutto se accostato al nostro sistema scorrevole **Star Fluid**.

One system, many advantages

Not just aesthetics, but construction flexibility and a range of options.

Fine has been designed to be a **flexible system** in construction terms as well.

With a single kit of accessories and seals, cabinets with **4 mm thick wooden and glass doors** (with and without crossbeams) can be made using the specific structural seals.



Un sistema, molti vantaggi

Non solo estetica, ma flessibilità costruttiva e possibilità di scelta.

Fine è stato concepito per essere un **sistema flessibile** anche in termini costruttivi.

Con un unico kit di accessori e guarnizioni, si possono realizzare armadi con **ante in legno** e **in vetro con spessore 4 mm** (con e senza traversi), utilizzando le apposite guarnizioni strutturali.



For wardrobes with 2 or 3 doors

A unique design that will leave you speechless

Thanks to its specific **framed design**, systems with 2 or 3 doors can be created **without the need to add and use handles** of any kind.

An **aesthetical, practical and economical advantage** that is certainly unrivalled.



Per armadi a 2 e 3 ante

Un design unico che vi lascerà senza fiato

Grazie al suo particolare **design a cassonetto**, è possibile realizzare sistemi a 2 e 3 ante **senza la necessità di aggiungere e utilizzare maniglie** di alcun tipo.

Un **vantaggio estetico, pratico ed economico** decisamente impareggiabile.



Modern and Versatile

Compatible with our sliding systems

Fine can be combined with **our main sliding systems for wardrobes:** Star Fluid, Comfort, which **can be easily installed** in the upper horizontal crossbeams, **thanks to self-drilling screws.**

Lower guides, for doors 17mm or 35mm above the floor, can be easily installed through the **plates positioned on the frame's lower horizontal crossbeams.**

The 28 mm / 40 mm frame is compatible with all the wardrobe sliding systems already in our catalogue. This **great advantage** makes the **system incredibly flexible.**

Moderno e Versatile

Compatibile con i nostri sistemi scorrevoli

Fine si abbina ai **nostri principali sistemi scorrevoli per armadi:** Star Fluid, Comfort, i quali **possono essere facilmente installati** nel traverso orizzontale superiore, **grazie a viti autopercoranti.**

Le guide inferiori, per ante da 17 mm o 35 mm di luce da terra, si installano liberamente grazie alle **piastre posizionate sul traverso orizzontale inferiore** del telaio.

Il telaio con spessore da 28 mm o da 40 mm è compatibile con tutti i sistemi scorrevoli per armadi già presenti nel nostro catalogo. Un **grande vantaggio** che rende il **sistema estremamente flessibile.**



Oxidised and painted finishes

For modern settings

Fine is available in the **standard finishes** we offer and in oxidised and painted finishes such as: **Metal Grey, Graphite and White (RAL 9002)**.

Finiture ossidate e verniciate

Per ambienti moderni

Fine è disponibile nelle **finiture standard** da noi fornite sia ossidate che verniciate come: **Metal Grey, Grafite e Bianco (RAL 9002)**.



With a **single sliding system kit**, it's also possible to combine a glass and a wooden door - **yet another aesthetic and technical advantage**.

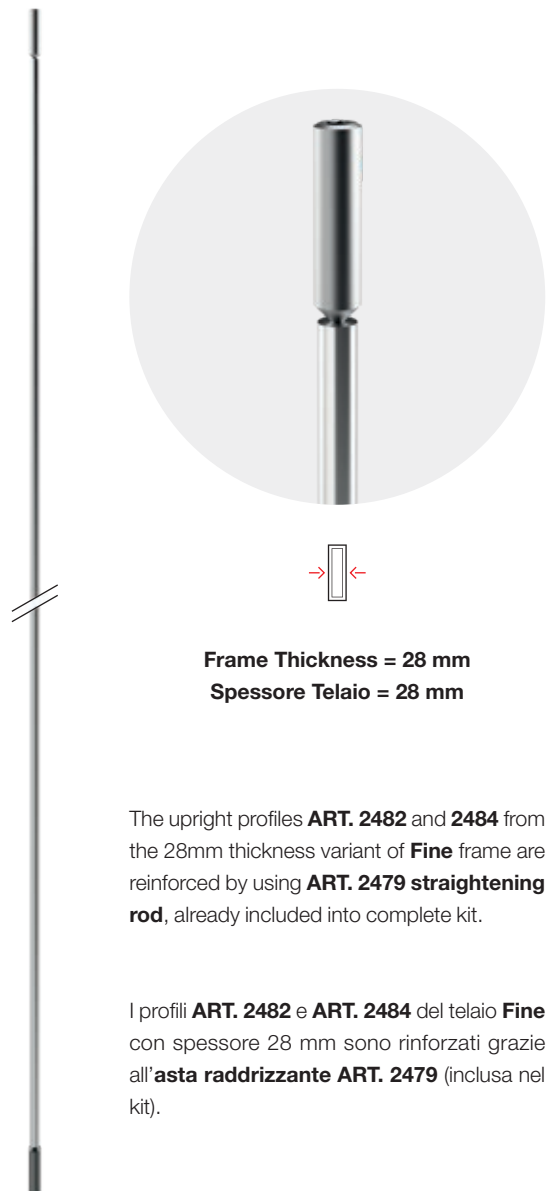

È inoltre possibile, **con un unico kit di scorrevoli**, abbinare sia un'anta in legno che un'anta in vetro: **un ulteriore vantaggio tecnico ed estetico**.





Frame Thickness = 28 mm
Spessore Telaio = 28 mm

The upright profiles **ART. 2482** and **2484** from the 28mm thickness variant of **Fine** frame are reinforced by using **ART. 2479 straightening rod**, already included into complete kit.

I profili **ART. 2482** e **ART. 2484** del telaio **Fine** con spessore 28 mm sono rinforzati grazie all'**asta raddrizzante ART. 2479** (inclusa nel kit).

Fine		COMPLETE BOX KIT / KIT COMPLETO IN SCATOLA		
K	Complete kit / Kit completo			
	1402		Frame Thickness 28 mm — Wood/Glass Doors 4 mm Spessore Telaio 28 mm — Ante Legno/Vetro 4 mm	
	1403		Frame Thickness 40 mm — Wood/Glass Doors 4 mm Spessore Telaio 40 mm — Ante Legno/Vetro 4 mm	
		0	Internal Door — Standard Drilling / Anta Interna — Foratura Standard	
		1	External Door — Standard Drilling / Anta Esterna — Foratura Standard	
				01 750 x 2700 mm
				02 1000 x 2700 mm
				03 1400 x 2700 mm
				02 Brushed Anodized Silver / Argento Spazzolato
				15 Brushed Anodized Black / Nero Spazzolato
				17 Brushed Anodized Nickel / Nichel Spazzolato
				28 Metal Grey
				30 Graphite / Grafite
				39 White / Bianco (RAL 9002)

Fine		COMPLETE BLISTER KIT / KIT COMPLETO IN BLISTER		
B	Complete kit / Kit completo			
	1400	Crossbeam Accessories Accessori Trasverso		
		0		Frame Thickness 28 mm Spessore Telaio 28 mm
		1		Frame Thickness 40 mm Spessore Telaio 40 mm
				01 750 mm
				02 1000 mm
				03 1400 mm
				04 2700 mm
				02 Brushed Anodized Silver / Argento Spazzolato
				15 Brushed Anodized Black / Nero Spazzolato
				17 Brushed Anodized Nickel / Nichel Spazzolato
				28 Metal Grey
				30 Graphite / Grafite
				39 White / Bianco (RAL 9002)

Fine		COMPLETE ACCESSORIES KIT / KIT ACCESSORI COMPLETI	
K	Complete kit / Kit completo		
		1400	Door Accessories Accessori per Anta
			0 Standard Drilling Foratura Standard
			00 Frame joints + Guide fixing plate Giunti per Angolo + Piastre Scorrevoli
K	Complete kit / Kit completo		
		1401	Crossbeam Accessories Accessori per Traverso
			0 Crossbeam joints Giunti per Traverso

EXAMPLE / ESEMPIO

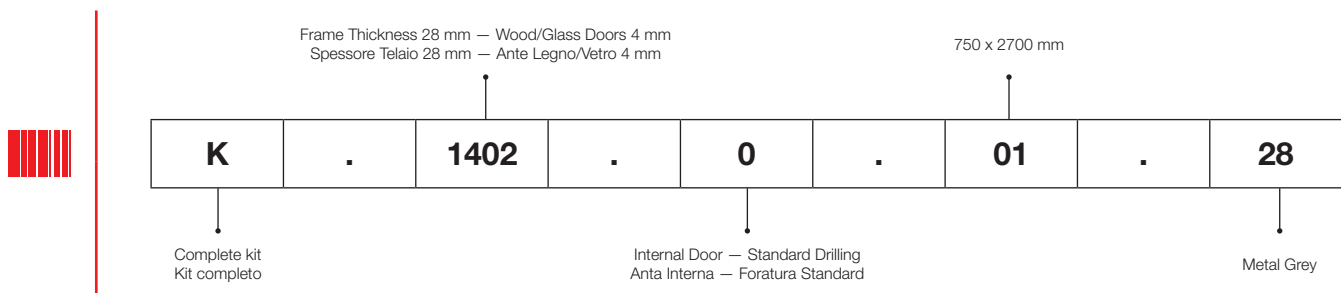

Tracks / Binari		ALUMINUM FINISHES CODES / CODICI FINITURE ALLUMINIO	
CODE / CODICE	FINISH COLOR / COLORE FINITURA		
8 02 0.0	02 Brushed Anodized Silver / Argento Spazzolato		STANDARD
8 15 0.0	15 Brushed Anodized Black / Nero Spazzolato		SPECIAL
8 17 0.0	17 Brushed Anodized Nickel / Nichel Spazzolato		
8 28 0.0	28 Metal Grey		
8 30 0.0	30 Graphite / Grafite		
8 39 0.0	39 White / Bianco (RAL 9002)		

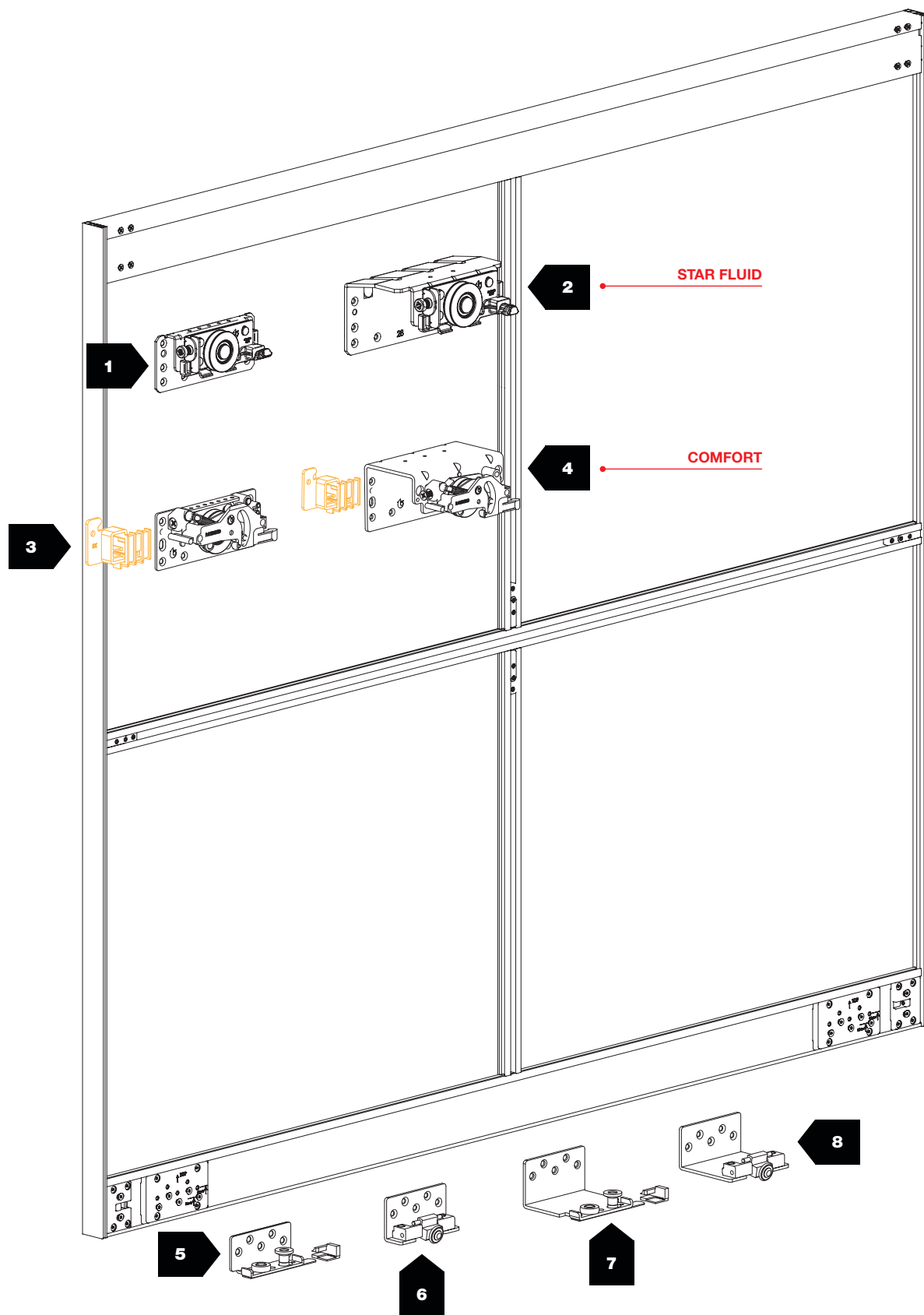

28 ÷ 40 mm



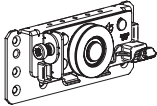
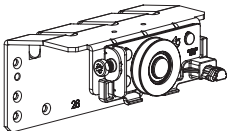
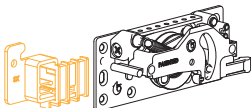
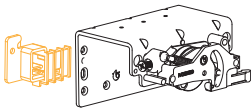

17 ÷ 35 mm

N°			kg		N°		kg		
1	3062		—	Slides Scorrevoli 28÷40 mm	5	582	—	Slides Scorrevoli 28÷40 mm	
2	3074		—	Slides Scorrevoli 28 mm	6	1902/N	—	Slides Scorrevoli 28÷40 mm	
	3075			Slides Scorrevoli 30 mm					
	3077			Slides Scorrevoli 40 mm					
3	2961		—	Slides Scorrevoli 28÷40 mm	7	586	—	Slides Scorrevoli 28 mm	
								499	Slides Scorrevoli 30 mm
									597
4	2966		—	Slides Scorrevoli 28 mm	8	1906/N	—	Slides Scorrevoli 28 mm	
	2967			Slides Scorrevoli 30 mm					
	2969			Slides Scorrevoli 40 mm					
						1903/N	—	Slides Scorrevoli 30 mm	
						1905/N	—	Slides Scorrevoli 40 mm	

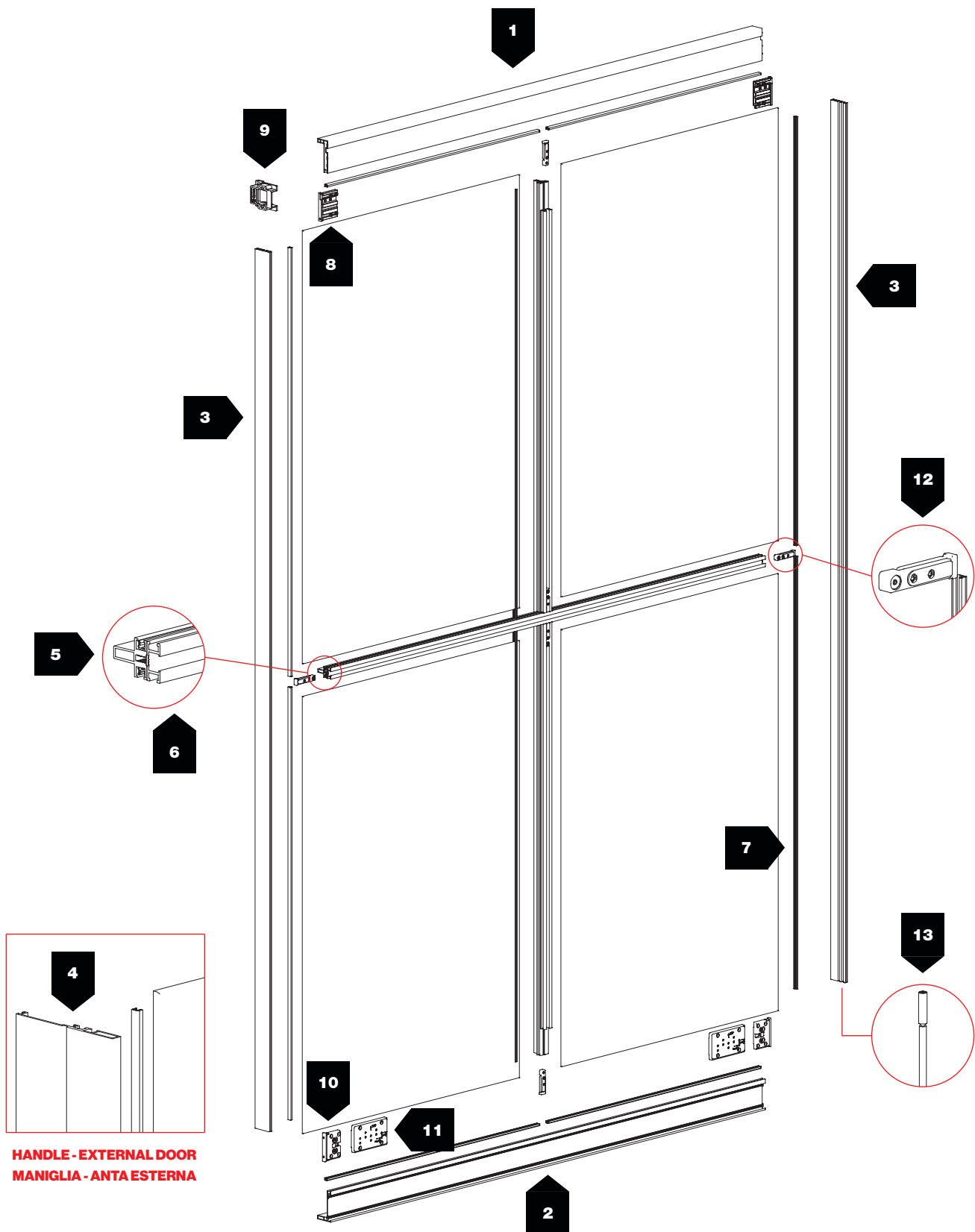

Fine

The new aluminium frame for sliding doors
Il nuovo telaio in alluminio per ante scorrevoli





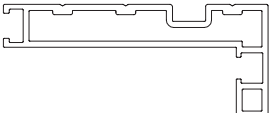
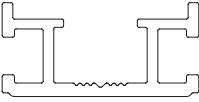
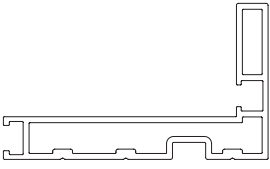

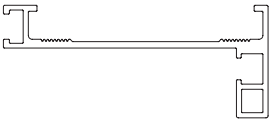
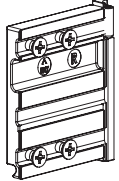
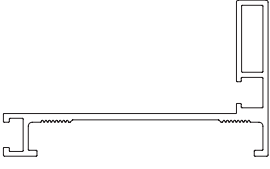
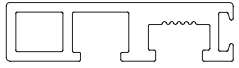
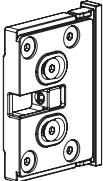
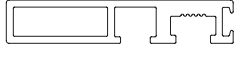
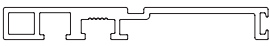
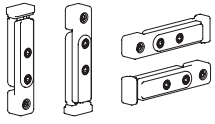
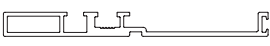
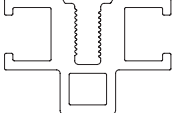
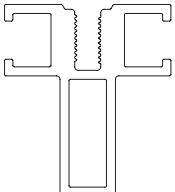
28 ÷ 40 mm



17 ÷ 35 mm

N°	Barcode	Image	kg	Dimensions	N°	Barcode	Image	kg	Dimensions
1	2477		—	Frames Telaio 28÷30 mm	6	2475		—	Frames Telaio 28÷40 mm
	2468		—	Frames Telaio 40 mm	7	2476		—	Frames Telaio 28÷40 mm
2	2481		—	Frames Telaio 28÷30 mm	8	2457		—	Frames Telaio 28÷40 mm
	2471		—	Frames Telaio 40 mm					
3	2482		—	Frames Telaio 28÷30 mm	10	2462		—	Frames Telaio 28÷40 mm
	2472		—	Frames Telaio 40 mm					
4	2484		—	Frames Telaio 28 mm	12	2463		—	Frames Telaio 28÷40 mm
	2474		—	Frames Telaio 40 mm					
5	2483		—	Frames Telaio 28÷30 mm					
	2473		—	Frames Telaio 40 mm					

Fine

The new aluminium frame for sliding doors
Il nuovo telaio in alluminio per ante scorrevoli

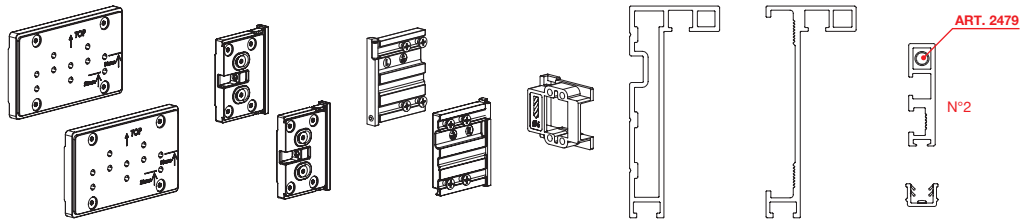
-  Kit for N.1 door
Kit per N.1 anta
-  Internal Door (2 doors)
Anta Interna (2 ante)
-  Internal/External Door (3 doors)
Anta Interna/Esterna (3 ante)
-  Standard Drilling
Foratura Standard





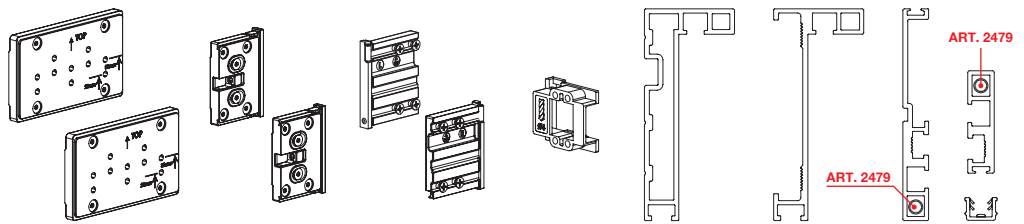

CODE	FINISHES / FINITURE		SIZE / DIMENSIONI
K.1402.0.01	.02 .15 .17 .28 .30 .39	28 mm	750 x 2700 mm
K.1402.0.02	.02 .15 .17 .28 .30 .39		1000 x 2700 mm
K.1402.0.03	.02 .15 .17 .28 .30 .39		1400 x 2700 mm

-  Kit for N.1 door
Kit per N.1 anta
-  External Door
Anta Esterna
-  Standard Drilling
Foratura Standard



CODE	FINISHES / FINITURE		SIZE / DIMENSIONI
K.1402.1.01	.02 .15 .17 .28 .30 .39	28 mm	750 x 2700 mm
K.1402.1.02	.02 .15 .17 .28 .30 .39		1000 x 2700 mm
K.1402.1.03	.02 .15 .17 .28 .30 .39		1400 x 2700 mm

-  Kit for N.1 door
Kit per N.1 anta
-  Internal Door (2 doors)
Anta Interna (2 ante)
-  Internal/External Door (3 doors)
Anta Interna/Esterna (3 ante)
-  Standard Drilling
Foratura Standard

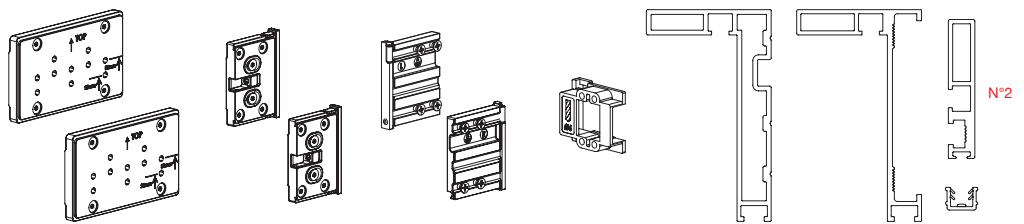

CODE	FINISHES / FINITURE		SIZE / DIMENSIONI
K.1403.0.01	.02 .15 .17 .28 .30 .39	40 mm	750 x 2700 mm
K.1403.0.02	.02 .15 .17 .28 .30 .39		1000 x 2700 mm
K.1403.0.03	.02 .15 .17 .28 .30 .39		1400 x 2700 mm

-  Kit for N.1 door
Kit per N.1 anta
-  External Door
Anta Esterna
-  Standard Drilling
Foratura Standard

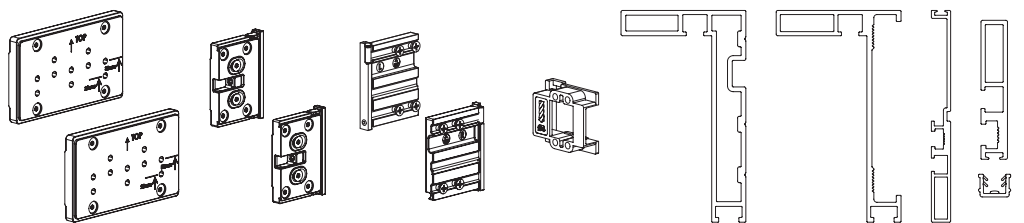

CODE	FINISHES / FINITURE		SIZE / DIMENSIONI
K.1403.1.01	.02 .15 .17 .28 .30 .39	40 mm	750 x 2700 mm
K.1403.1.02	.02 .15 .17 .28 .30 .39		1000 x 2700 mm
K.1403.1.03	.02 .15 .17 .28 .30 .39		1400 x 2700 mm

FINISHES / FINITURE	FINISHES / FINITURE	FINISHES / FINITURE	FINISHES / FINITURE	FINISHES / FINITURE	FINISHES / FINITURE
.02 Brushed Anodized Silver Argento Spazzolato	.15 Brushed Anodized Black Nero Spazzolato	.17 Brushed Anodized Nickel Nichel Spazzolato	.28 Metal Grey	.30 Graphite Grafite	.39 White (RAL 9002) Bianco (RAL 9002)

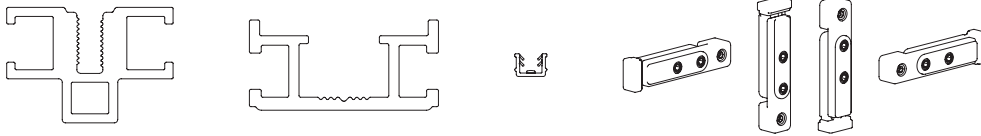

 Crossbeam Accessories
Accessori Traverso

CODE	FINISHES / FINITURE		SIZE / DIMENSIONI
B.1400.0.01	.02 .15 .17 .28 .30 .39	28 mm	750 mm
B.1400.0.02	.02 .15 .17 .28 .30 .39		1000 mm
B.1400.0.03	.02 .15 .17 .28 .30 .39		1400 mm
B.1400.0.04	.02 .15 .17 .28 .30 .39		2700 mm

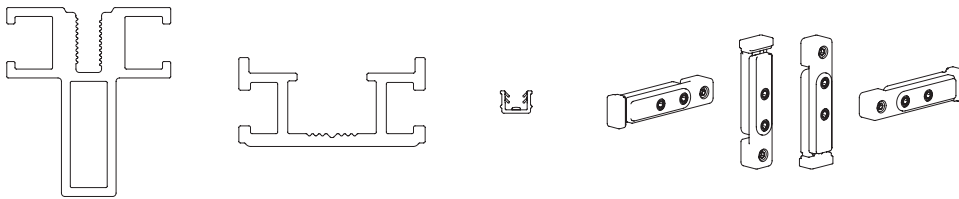

 Crossbeam Accessories
Accessori Traverso

CODE	FINISHES / FINITURE		SIZE / DIMENSIONI
B.1400.1.01	.02 .15 .17 .28 .30 .39	40 mm	750 mm
B.1400.1.02	.02 .15 .17 .28 .30 .39		1000 mm
B.1400.1.03	.02 .15 .17 .28 .30 .39		1400 mm
B.1400.1.04	.02 .15 .17 .28 .30 .39		2700 mm

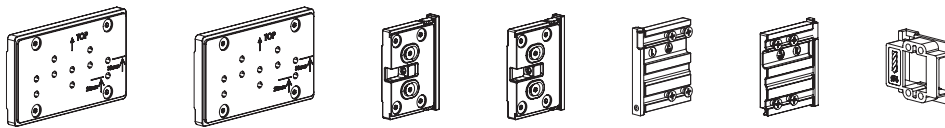

 Door Accessories
Accessori Anta

CODE	
K.1400.0.00	28 ÷ 40 mm

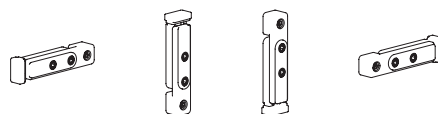

 Crossbeam Accessories
Accessori Traverso

CODE	
K.1401.0	28 ÷ 40 mm

FINISHES / FINITURE	.02	.15	.17	.28	.30	.39
	Brushed Anodized Silver Argento Spazzolato	Brushed Anodized Black Nero Spazzolato	Brushed Anodized Nickel Nichel Spazzolato	Metal Grey	Graphite Grafite	White (RAL 9002) Bianco (RAL 9002)

MEASUREMENTS DESCRIPTION / DESCRIZIONE MISURE

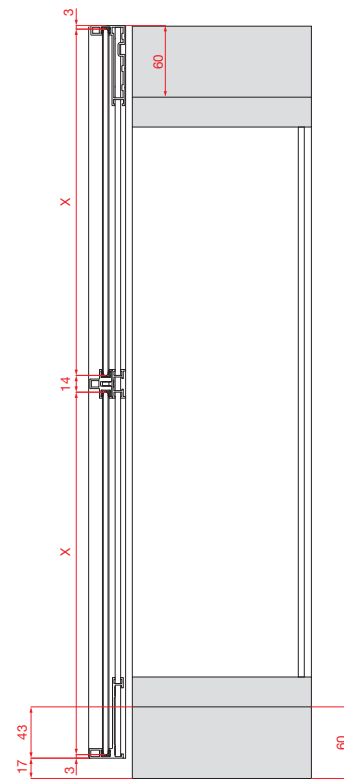
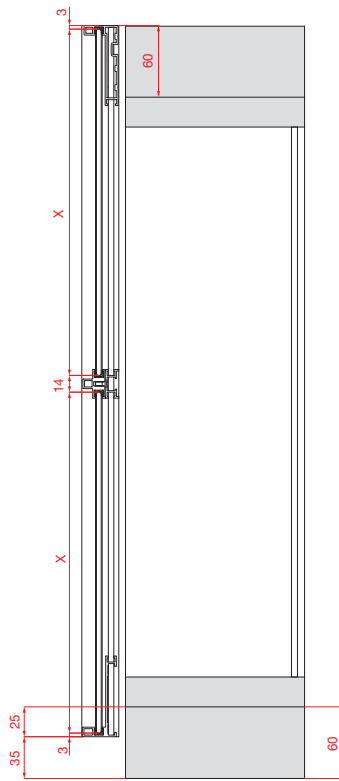

MEASUREMENTS DESCRIPTION / DESCRIZIONE MISURE

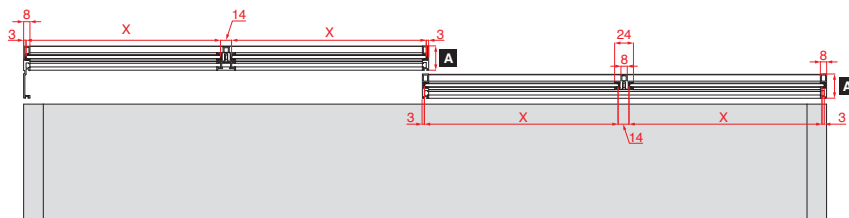
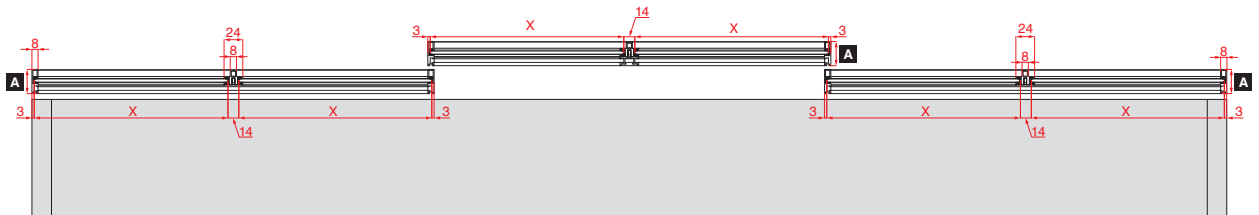

28 mm

A = 31



40 mm

A = 42

MEASUREMENTS DESCRIPTION / DESCRIZIONE MISURE

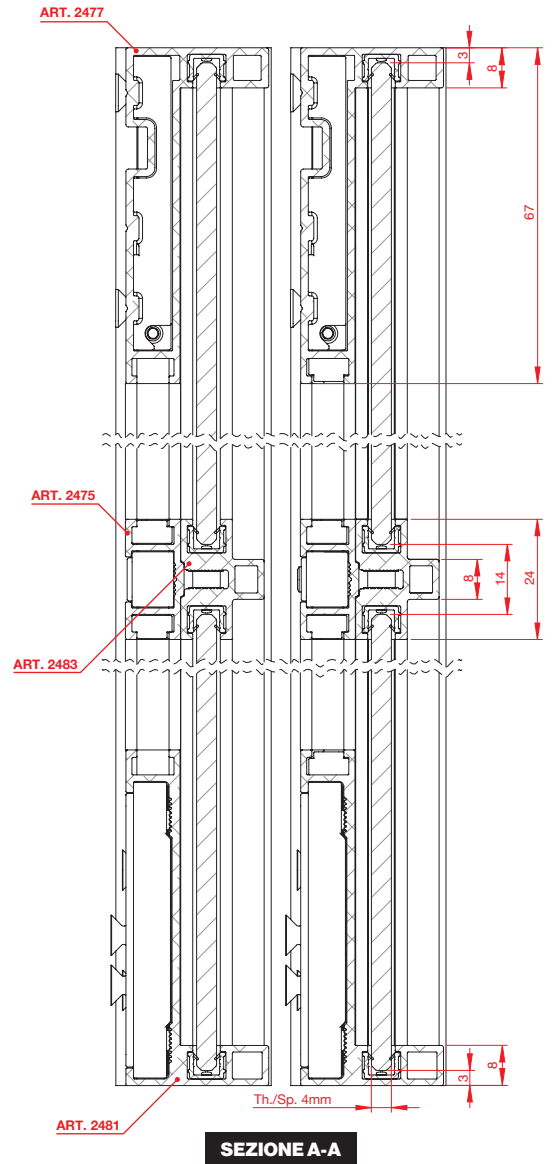
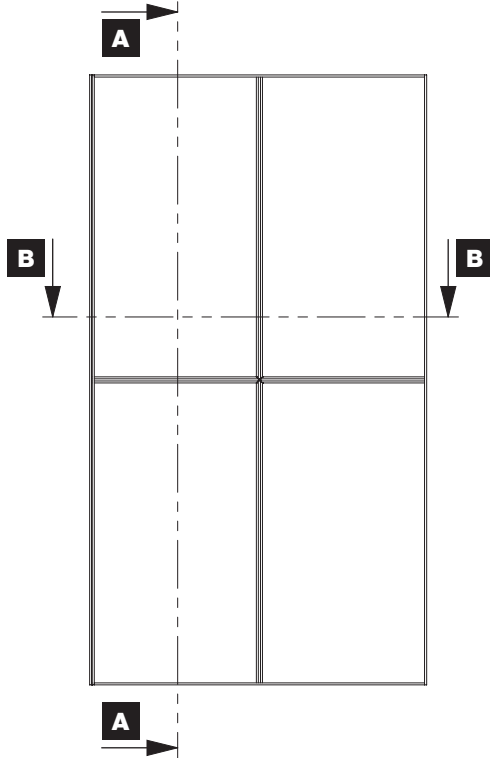

SEZIONE A-A

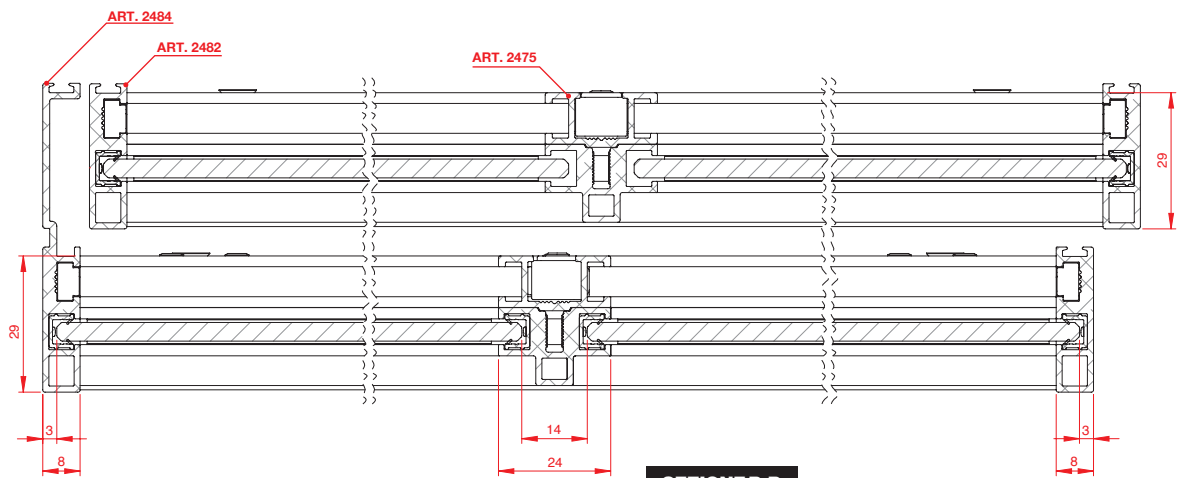

SEZIONE B-B



FRAME THICKNESS 28 mm / SPESSORE TELAIO 28 mm

MEASUREMENTS DESCRIPTION / DESCRIZIONE MISURE

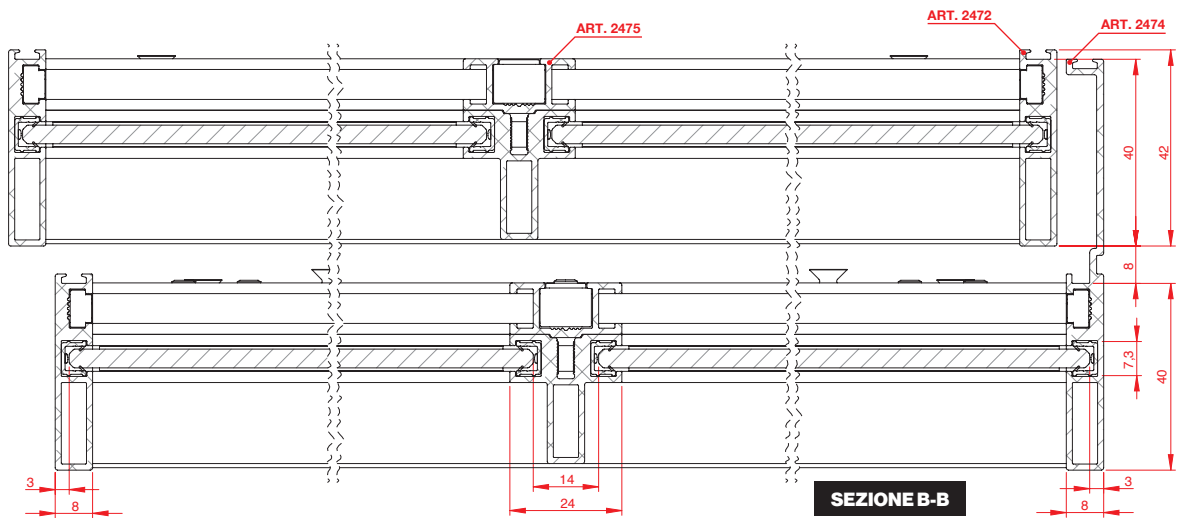
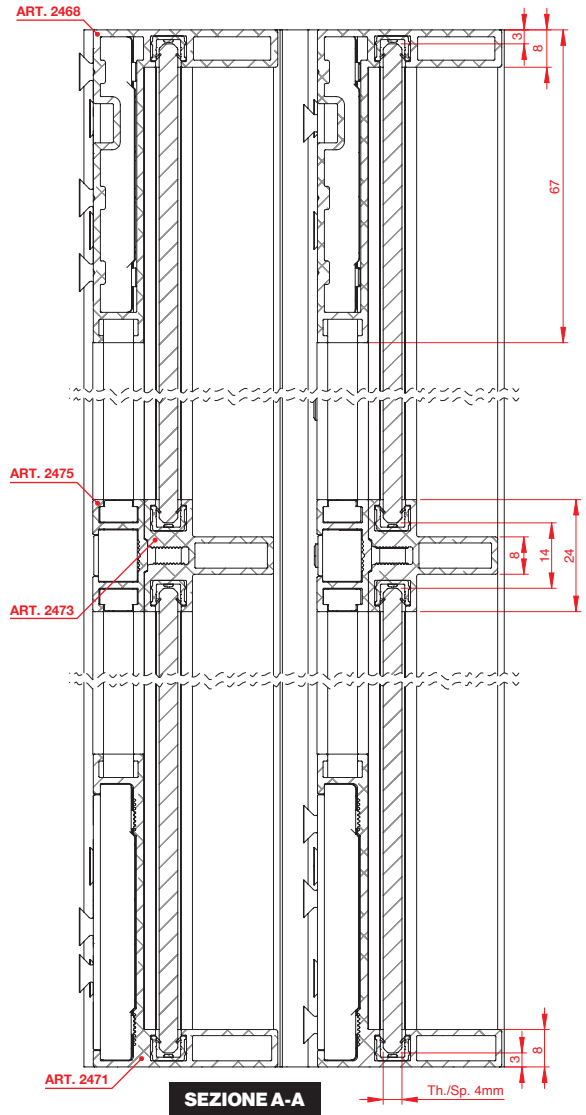
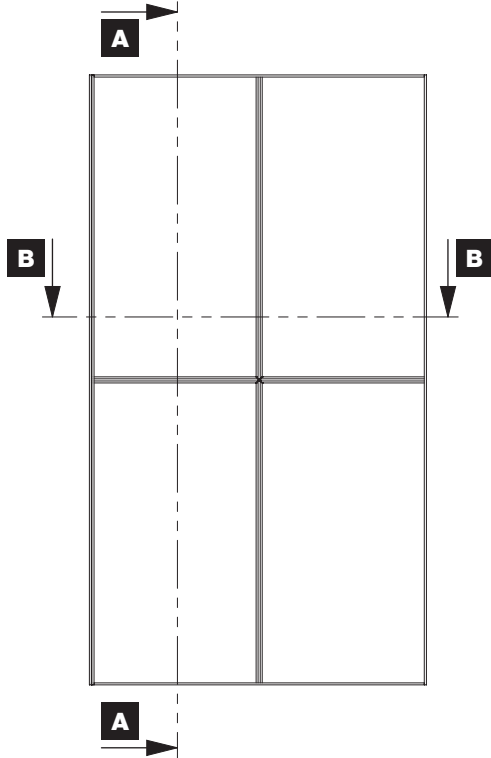

FRAME THICKNESS 40 mm / SPESSORE TELAIO 40 mm



www.ternoscorrevoli.com/fine



Terno Scorrevoli S.p.A.

**Via Ravenna, 4 - 20814 Varedo (MB) ITALY
Phone +39 0362 543001 - Fax +39 0362 582290**

**terno@ternoscorrevoli.com
www.ternoscorrevoli.com**