

# PROFIL LED CORNER10 BC/UX 4050 ANOD.



max 10 mm



Katowe



Meblowe



- dwa kąty świecenia: 30° i 60°
- ukryte mocowanie
- szeroki wybór akcesoriów, 7 rodzajów kloszy



Wzory przemysłowe EU



CE



Wyprodukowane w Polsce



Kup produkt

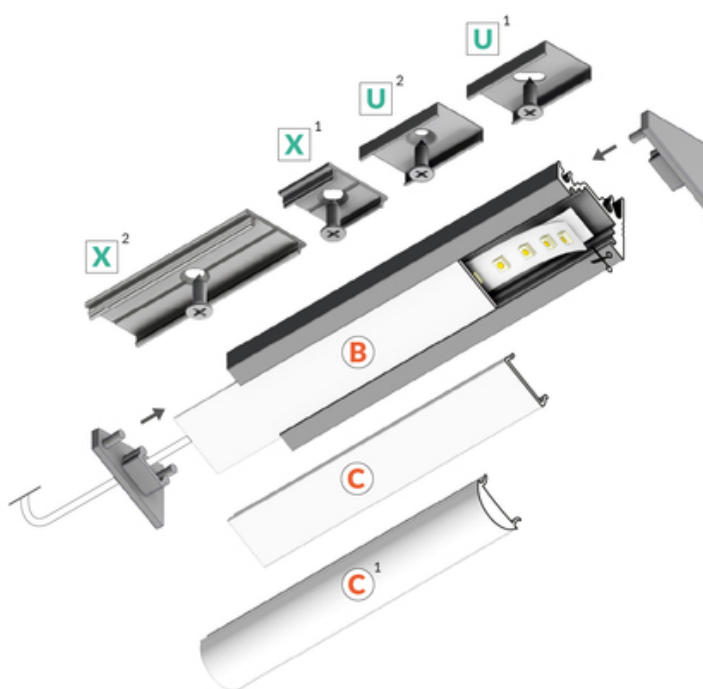
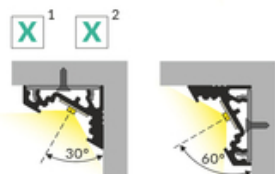
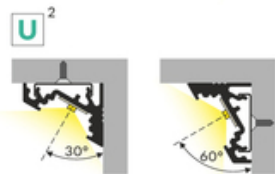
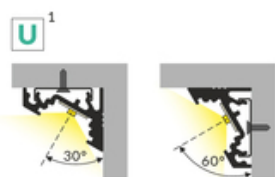
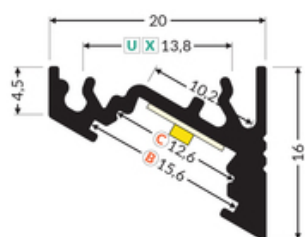

TOPMET LIGHT KŁOSOWICZ WIŚNIEWSKI sp. z o.o.

Ostrowska 354 | 61-312 Poznań | POLAND

tel.: +48 61 872 75 00

info@topmet.pl

data wygenerowania karty pdf: 30.10.2024



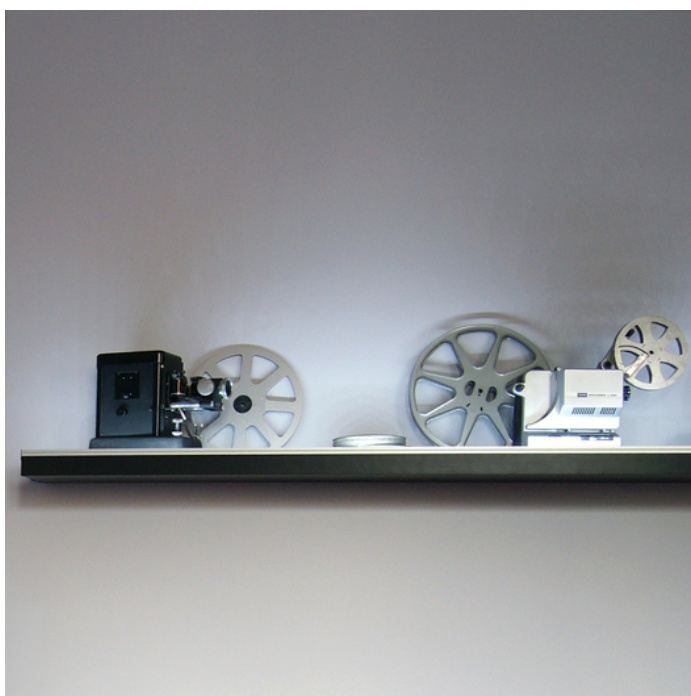

## Informacje podstawowe

Indeks: 83190020 EAN: 5901597249443 Materiał: aluminium Kolor: anodowany Długość [mm]: 4050 Szerokość [mm]: 20 Wysokość [mm]: 16 Waga [kg]: 0.786 Producent: TOPMET Kraj pochodzenia, wytworzenia: PL	Jednostka miary: szt. Wymiary opakowania jednostkowego [mm]: 4050 x 20 x 16 Opakowanie zbiorcze [szt]: 40 Typ opakowania zbiorczego: pakiet Waga produktu z opakowaniem zbiorczym [kg]: 31.44
--	---

## DOSTĘPNE KOLORY



## DOSTĘPNE WARIANTY

1000 mm, 2000 mm, 3000 mm, 4050 mm

## Dopasowane elementy

### KLOSZE DO PROFILI LED



## ZAŚLEPKI DO PROFILI LED



**(EOL) zaślepka  
CORNER10 szary [20szt]**  
index: 83150022



**(EOL) zaślepka  
CORNER10 srebro  
[20szt]**  
index: 83150040



**zaślepka CORNER10  
gen2 szary [20szt]**  
index: 83990022



**zaślepka CORNER10  
gen2 srebro [20szt]**  
index: 83990040



**zaślepka CORNER10  
gen2 z otworem szary  
[20szt]**  
index: 83980022



**zaślepka CORNER10  
gen2 z otworem srebro  
[20szt]**  
index: 83980040

## ŁĄCZNIKI DO PROFILI LED



**łącznik CORNER10 90st  
anod. /op**  
index: 83110020



**łącznik X 180st [1szt]**  
index: 76350000

## UCHWYTY DO PROFILI LED



**uchwyt U cone inox  
[20szt]**  
index: 76620000

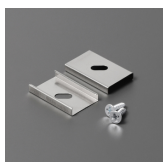

**uchwyt U inox [20szt]**  
index: 76380000

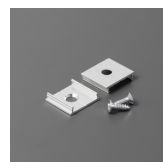

**uchwyt X [20szt]**  
index: 76260000