

Profil LED SURFACE

- 1 - profil LED SURFACE
- 2 - taśma LED
- 3a - klosz SU/GR/CO mleczny/szron/transparentny
- 3b - klosz SU/GR/CO soczewka 60°
- 3c - klosz SU/GR/CO klik transparentny/mleczny
- 4 - zaślepka SU
- 5 - przewód

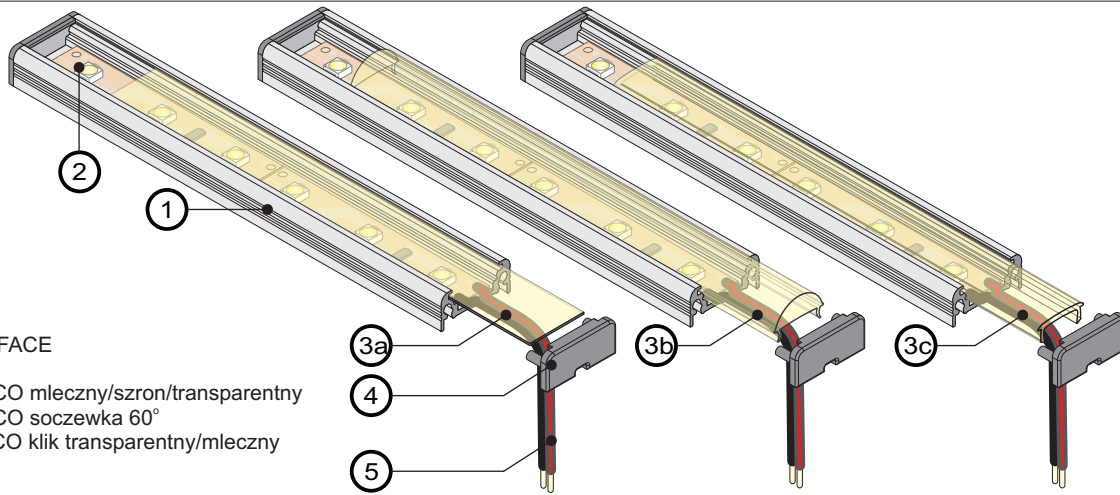

ZASTOSOWANIE

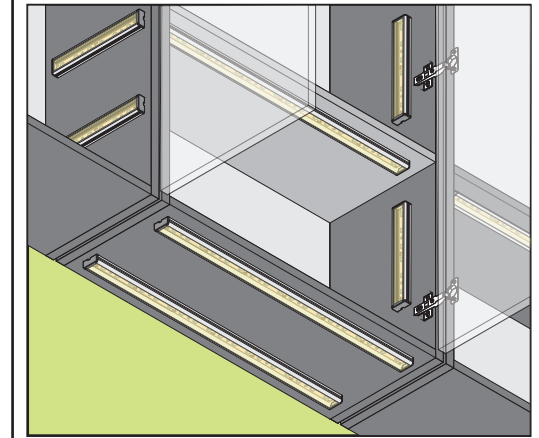

PROFIL LED SURFACE

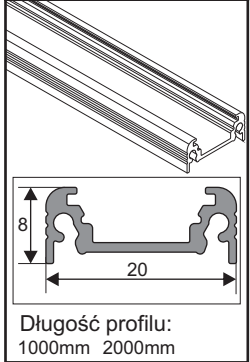

ZAŚLEPKA SU

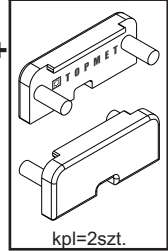

TAŚMY LED

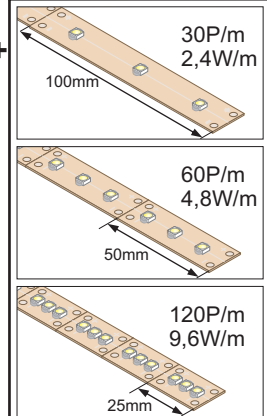

KLOSZE SU/GR/CO

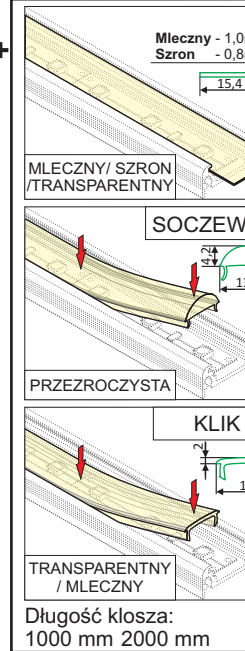

MOCOWANIE PROFILU

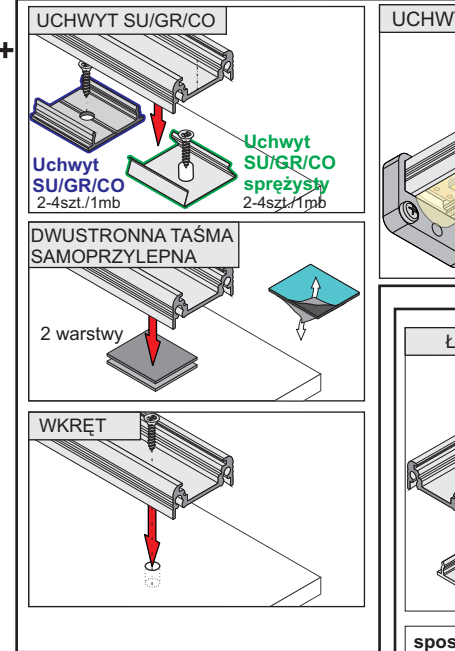

UCHWYT SU PROSTY

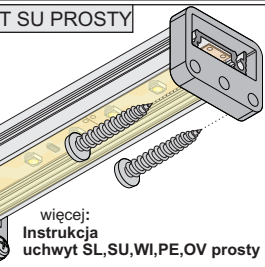

ŁĄCZENIE PROFILI

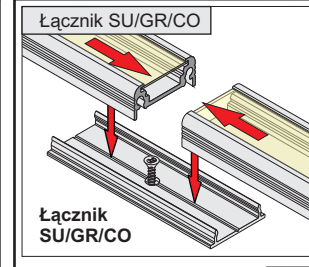

WŁĄCZNIK LED SU/GR/CO

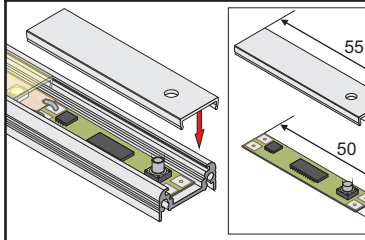

Łącznik L SU

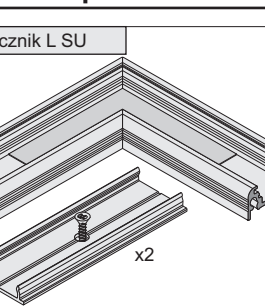

Łącznik SU/GR/CO

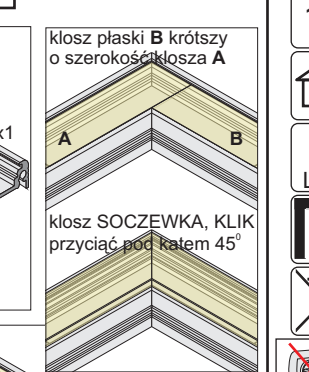

PRZEWÓD / WTYCZKA / KONEKTOR

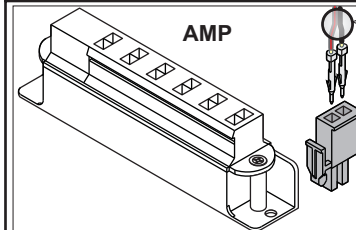

mini złącze

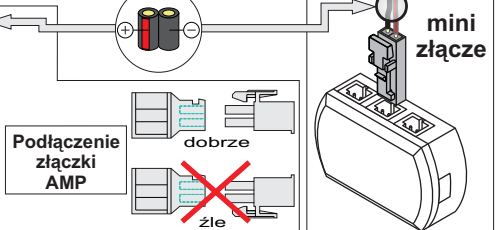

TRANSFORMATORY

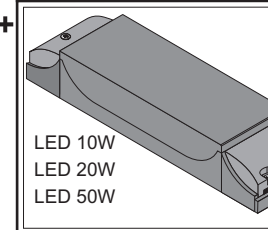

LED 6W

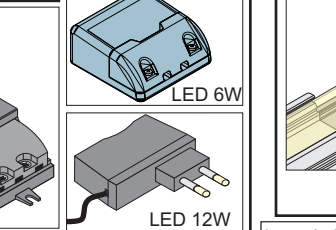

sposób montażu

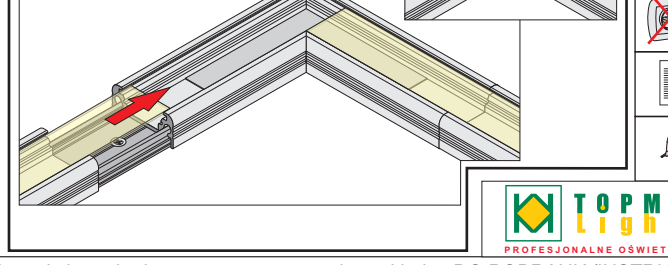

12V



TOPMET
Light
PROFESJONALNE OŚWIETLENIE